

Hold <b>49</b>	Skive <b>1</b>	<b>Annette Munkbøl</b>		
Aalborg		Aalborg Skyttekreds		VS2
		Nordjysk mesterskab 2018	Aalborg Skyttekreds	
Prøve		1:	9.9	←
		2:	10.3	←
		3:	10.1	↗
		4:	9.6	→
		5:	10.2	→
		6:	10.4	↗
		Serie	58	
		Total	0	
20 Skud		1:	10.1	↗
		2:	10.7x	↘
		3:	10.3	←
		4:	10.3	↘
		5:	9.5	↘
		6:	8.7	↙
		7:	10.1	→
		8:	9.5	←
		9:	9.7	→
		10:	9.9	↘
		Serie	94	
		Total	94	
20 Skud		11:	9.9	↗
		12:	9.4	↗
		13:	10.5x	↘
		14:	10.2	↗
		15:	9.7	↗
		16:	10.3	→
		17:	9.4	↘
		18:	10.1	←
		19:	10.7x	↘
		20:	9.5	↘
		Serie	95	
		Total	189	

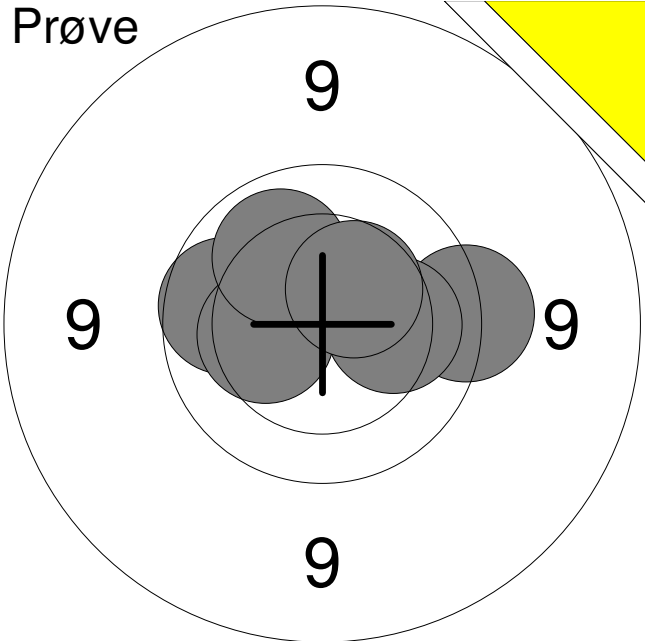

1:	9.2	↗
2:	9.1	↗
3:	9.8	↗
4:	10.1	→
5:	9.6	↗
6:	9.4	↗
7:	10.6x	↗
8:	10.8x	↓
<b>Serie</b>		<b>75</b>
<b>Total</b>		<b>0</b>

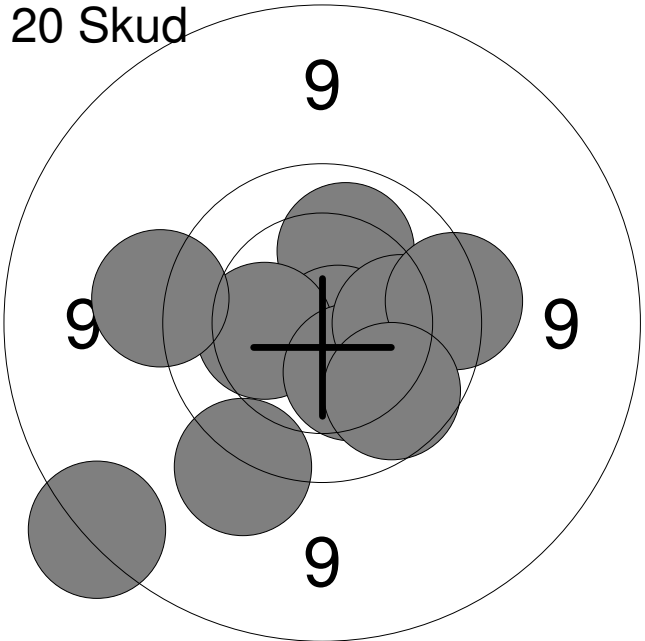
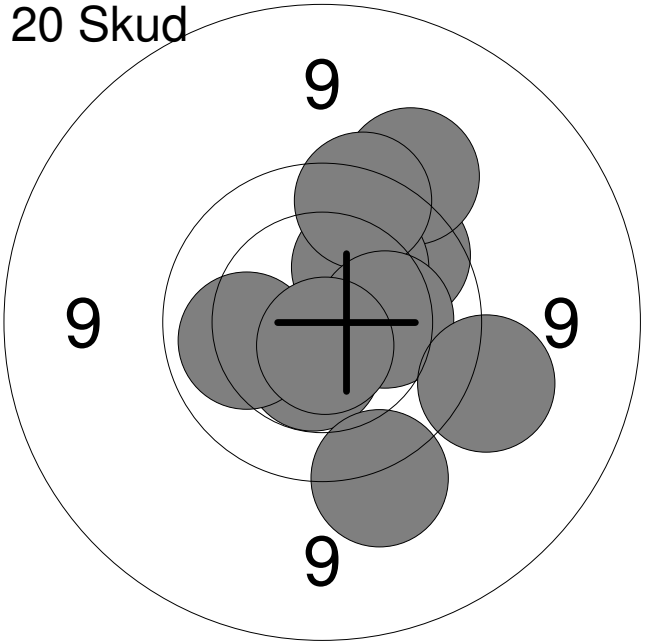
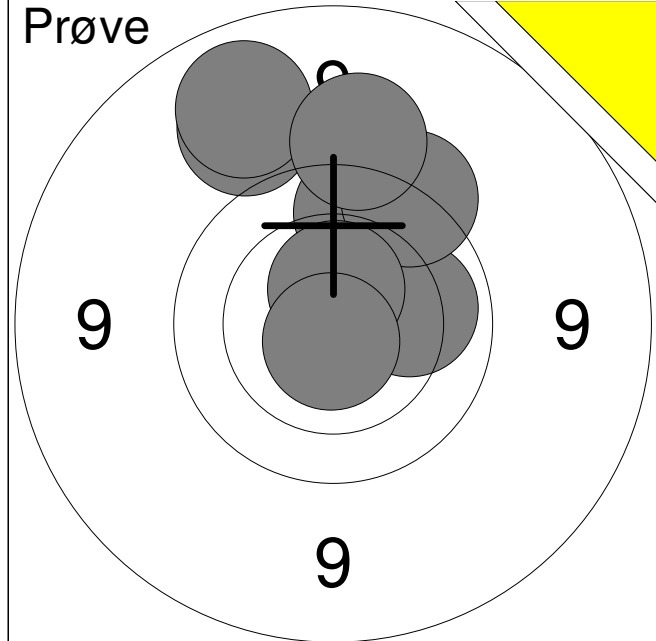
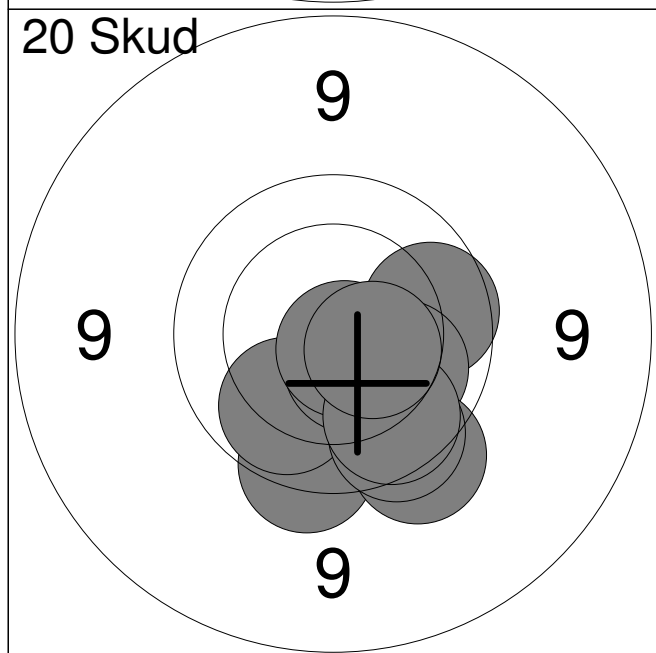

1:	9.7	↓
2:	9.9	→
3:	10.0	↓
4:	10.6x	↓
5:	10.1	↘
6:	10.7x	↓
7:	9.6	↓
8:	9.8	↓
9:	9.9	↓
10:	10.5	↘
<b>Serie</b>		<b>95</b>
<b>Total</b>		<b>95</b>

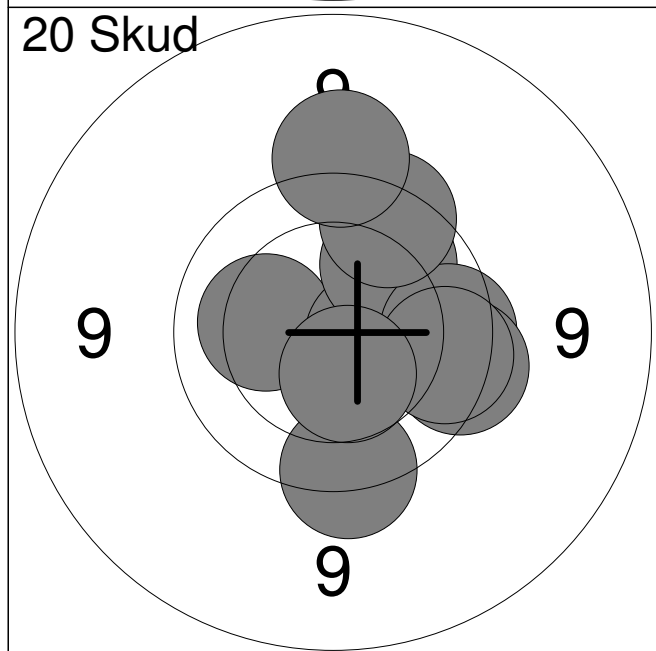

11:	10.2	←
12:	10.5x	→
13:	10.0	↗
14:	9.8	→
15:	9.7	↘
16:	9.6	↓
17:	9.8	→
18:	10.5	↓
19:	9.7	↗
20:	9.4	↗
<b>Serie</b>		<b>94</b>
<b>Total</b>		<b>189</b>

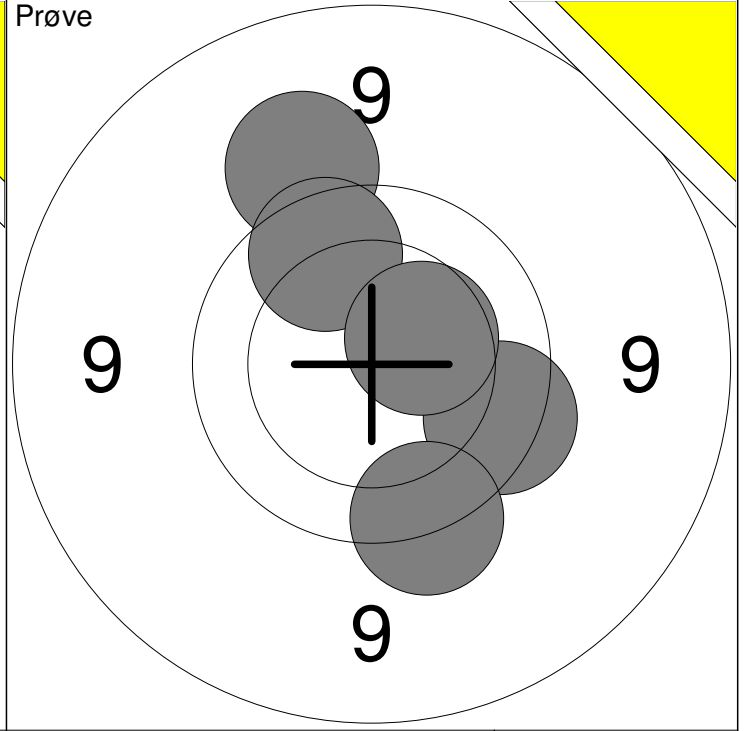
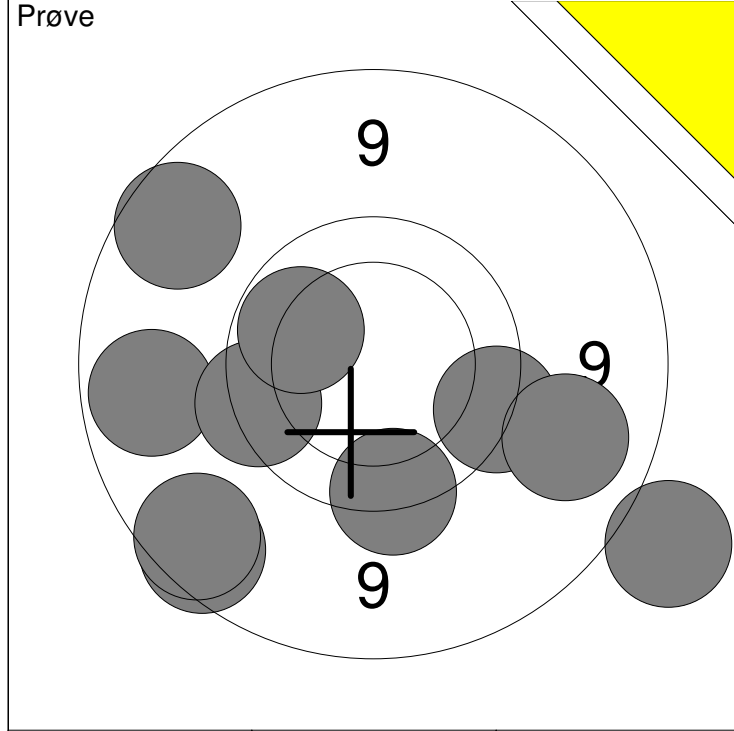

1: 8.9 ↙	6: 10.0 ↗	Serie	87
2: 8.9 ↙	7: 9.6 ↘		
3: 9.0 ←	8: 8.4 ↘	Total	0
4: 8.9 ↗	9: 9.1 ↘		
5: 9.7 ←	10: 9.6 ↓		

11: 9.4 ↗	Serie	46
12: 9.9 ↗		
13: 9.7 ↘	Total	0
14: 9.6 ↓		
15: 10.4 ↗		

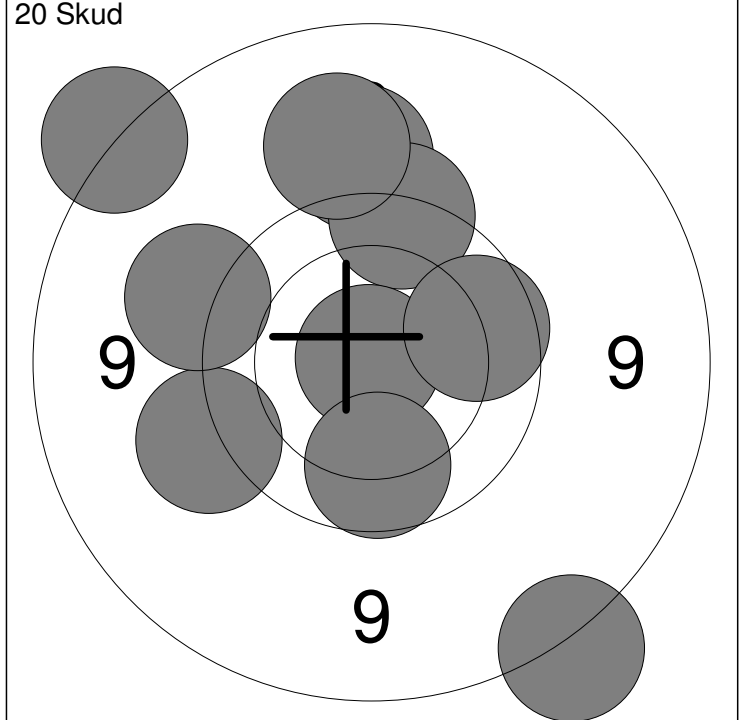
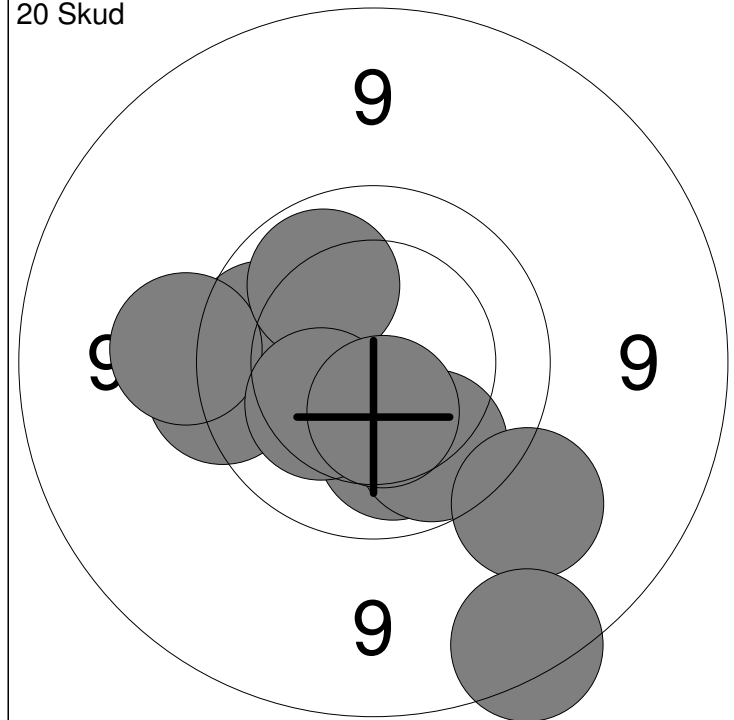

1: 9.9 ↙	6: 9.3 ↘	Serie	93
2: 10.1 ↓	7: 8.8 ↘		
3: 9.7 ←	8: 10.0 ↗	Total	93
4: 9.5 ←	9: 10.3 ↙		
5: 9.9 ↓	10: 10.5 ↓		

11: 9.3 ↗	16: 10.9x ↗	Serie	89
12: 9.5 ↙	17: 9.4 ↙		
13: 9.6 ↗	18: 9.9 ↓	Total	182
14: 9.2 ↗	19: 9.9 ↗		
15: 8.6 ↓	20: 8.7 ↙		

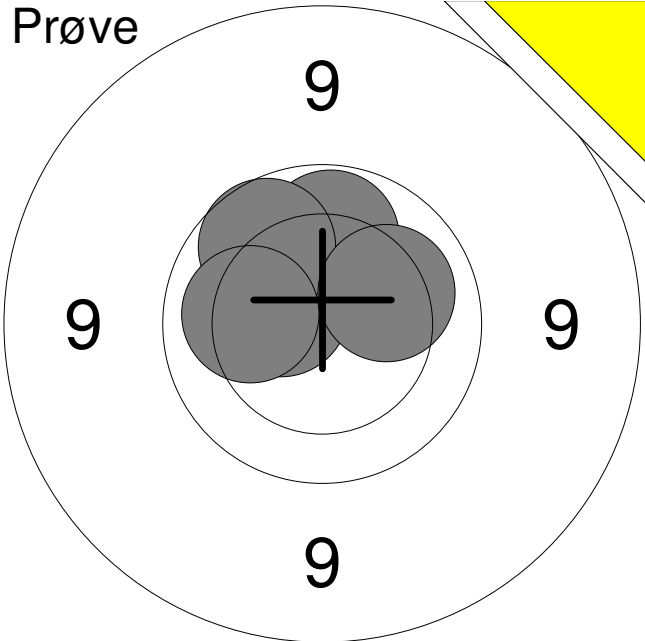
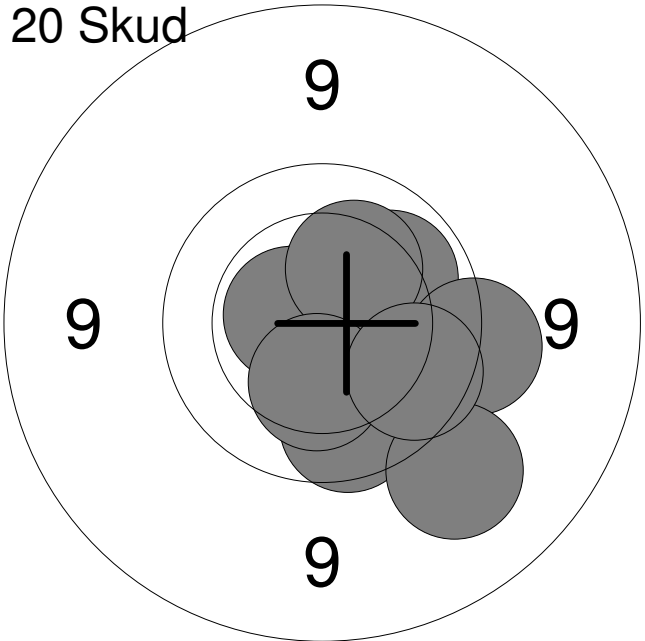
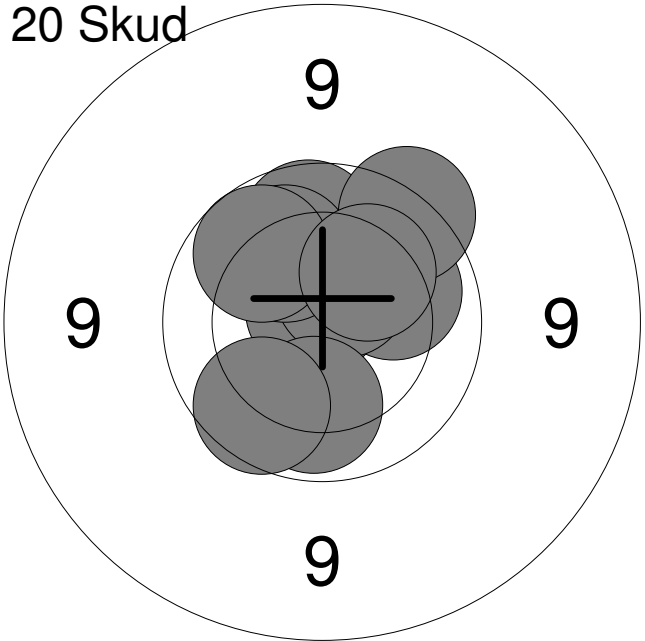
Hold <b>49</b>	Skive <b>4</b>	<b>Morten Andersen</b>		
Aalborg		Skytteforening Kimbrene		MSE2
		Nordjysk mesterskab 2018	Aalborg Skyttekreds	
Prøve		1:	10.5	↖
		2:	10.0	↑
		3:	9.9	↗
		4:	10.2	→
		5:	10.1	↖
		Serie	49	
		Total	0	
20 Skud		1:	10.5x	↗
		2:	10.1	↗
		3:	9.9	↓
		4:	10.8x	↗
		5:	10.6x	↖
		6:	10.3	↗
		7:	9.6	→
		8:	9.3	↓
		9:	10.3	↓
		10:	9.9	↘
		Serie	96	
		Total	96	
20 Skud		11:	10.1	↗
		12:	9.9	↑
		13:	10.8x	↗
		14:	10.5x	↗
		15:	10.1	↗
		16:	10.0	↓
		17:	9.9	↘
		18:	9.9	↗
		19:	9.7	↗
		20:	10.2	↗
		Serie	96	
		Total	192	

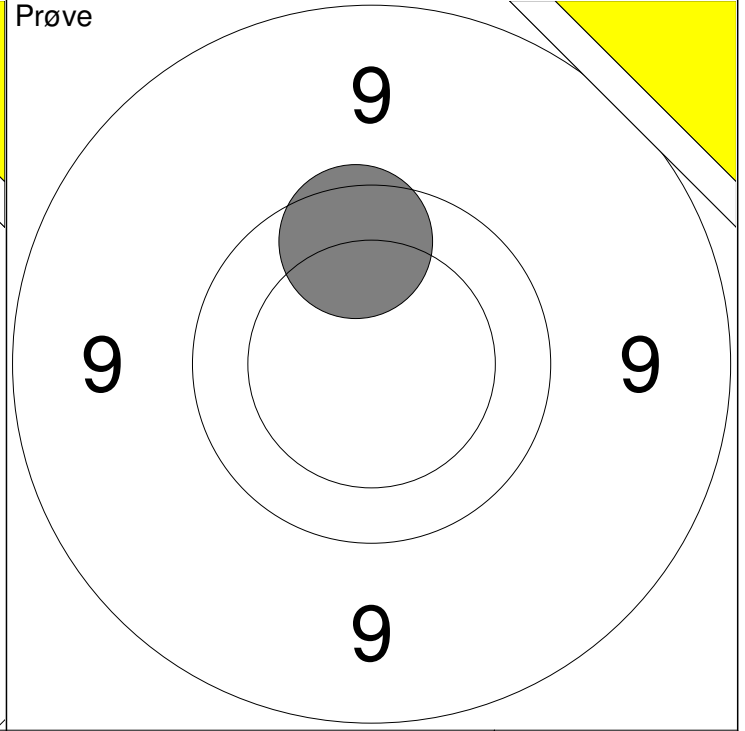
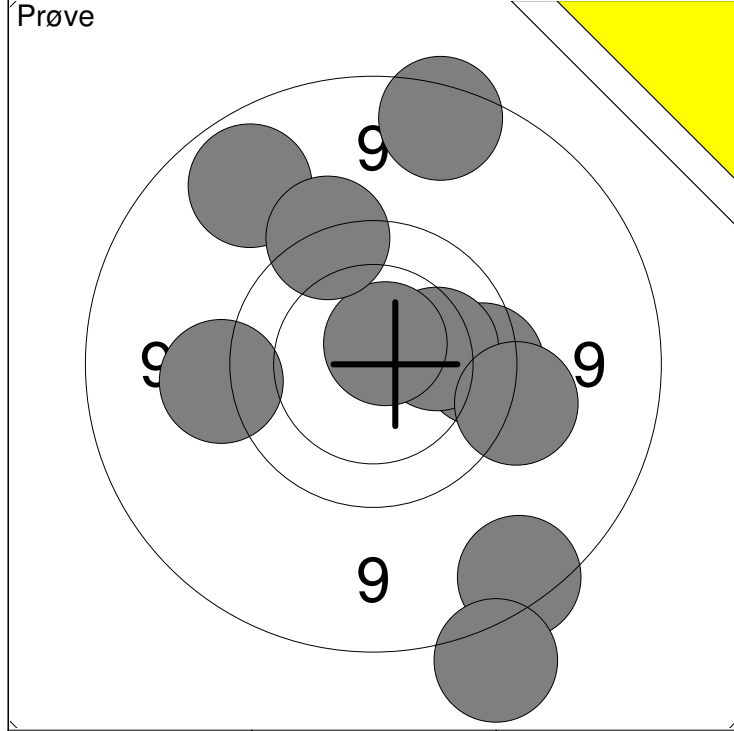

1: 9.8 →	6: 9.5 →	Serie	89
2: 10.2 →	7: 8.5 ↓		
3: 9.0 ↗	8: 10.7x ↗	Total	0
4: 8.8 ↗	9: 9.5 ←		
5: 8.8 ↓	10: 9.6 ↗		

11: 9.8 ↑	Serie	9
	Total	0

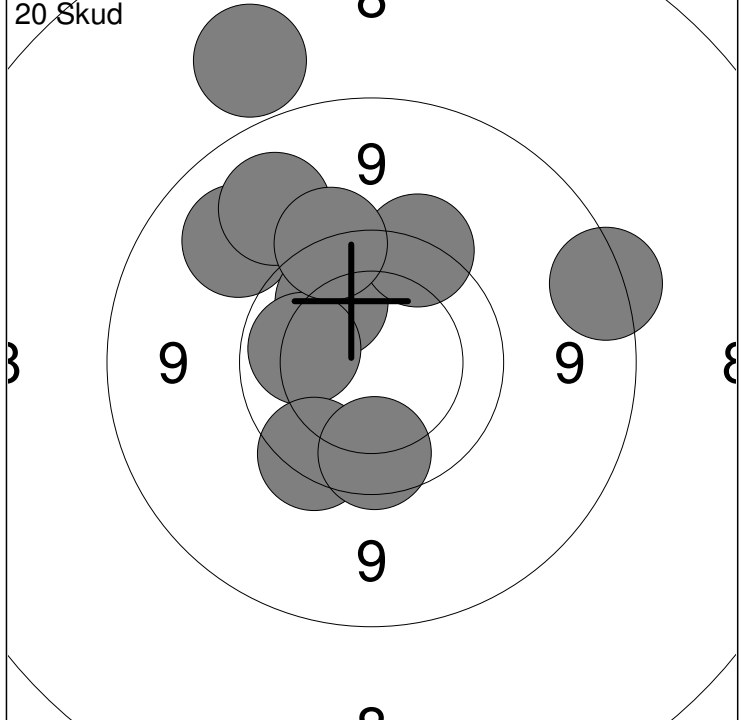
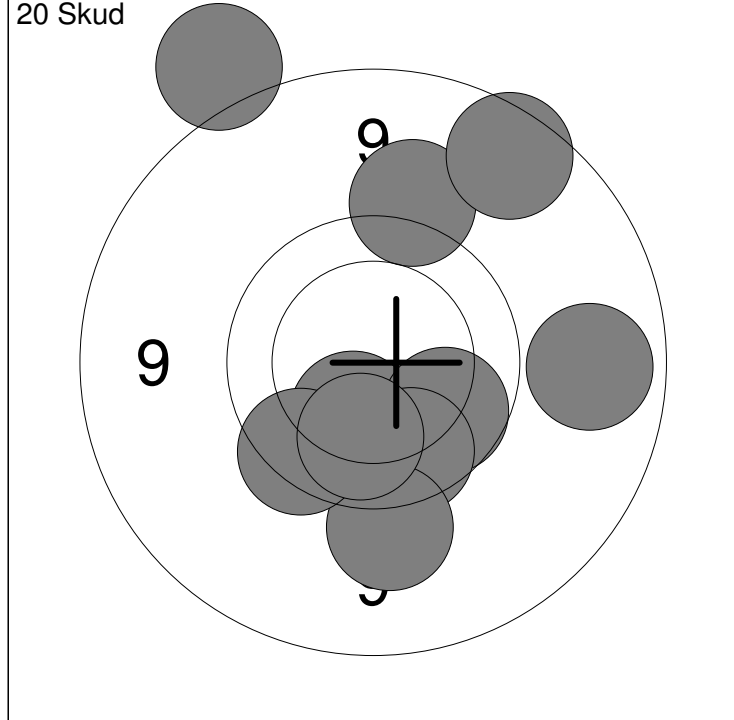

1: 10.3 ↓	6: 9.4 ↗	Serie	90
2: 9.0 →	7: 9.7 ↓		
3: 9.9 ↓	8: 10.0 ↓	Total	90
4: 9.9 ↓	9: 8.5 ↗		
5: 9.4 ↓	10: 8.9 ↗		

11: 9.2 ↗	16: 9.1 ↗	Serie	90
12: 10.0 ↗	17: 9.7 ↓		
13: 10.0 ←	18: 9.8 ↓	Total	180
14: 8.8 →	19: 9.6 ↗		
15: 8.4 ↗	20: 9.6 ↗		

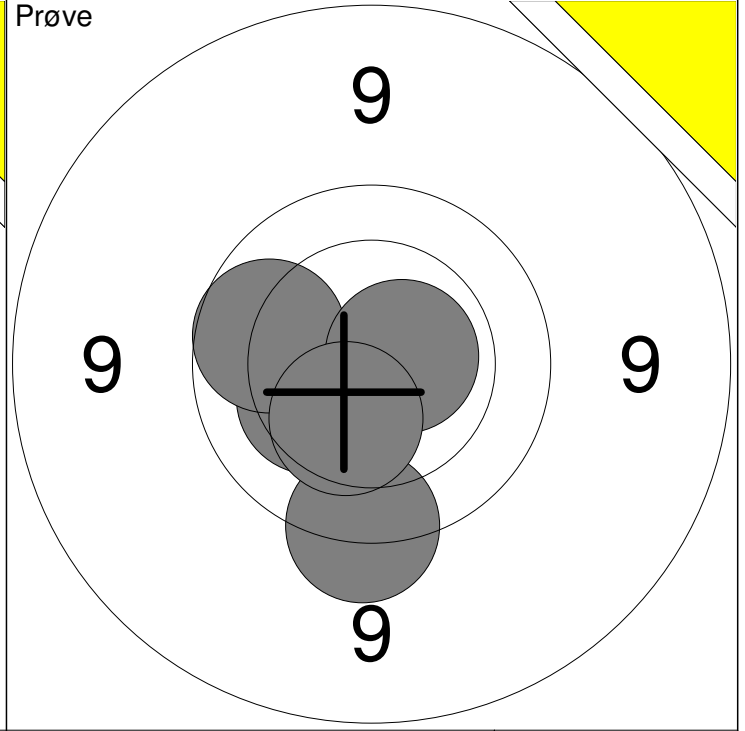
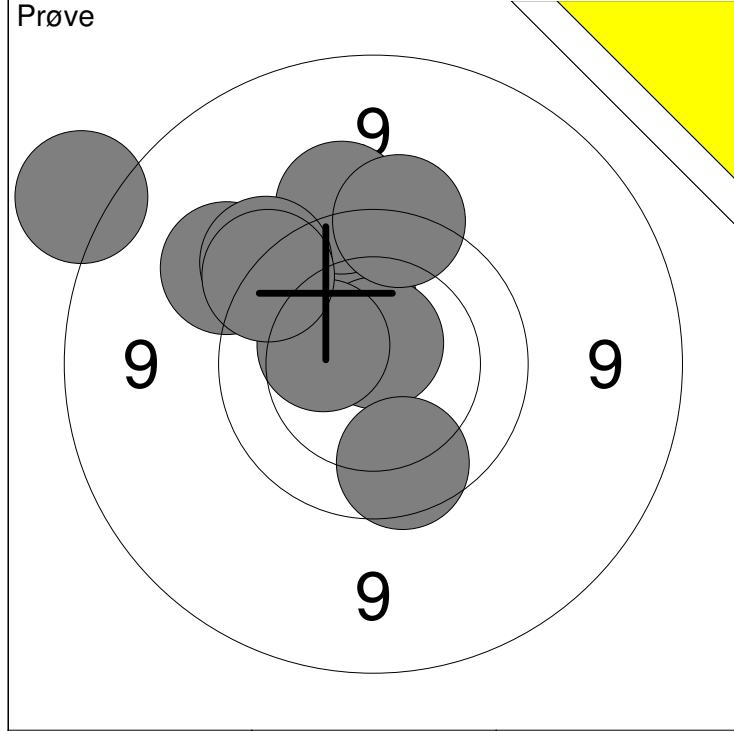

1: 8.6 ↗	6: 9.6 ↑	Serie	92
2: 9.4 ↗	7: 9.6 ↗		
3: 10.2 ↑	8: 9.9 ↓	Total	0
4: 10.7x ↑	9: 10.3 ←		
5: 9.5 ↑	10: 9.6 ↗		

11: 10.3 ↙	Serie	48
12: 9.9 ←		
13: 10.6x →	Total	0
14: 9.6 ↓		
15: 10.4 ↓		

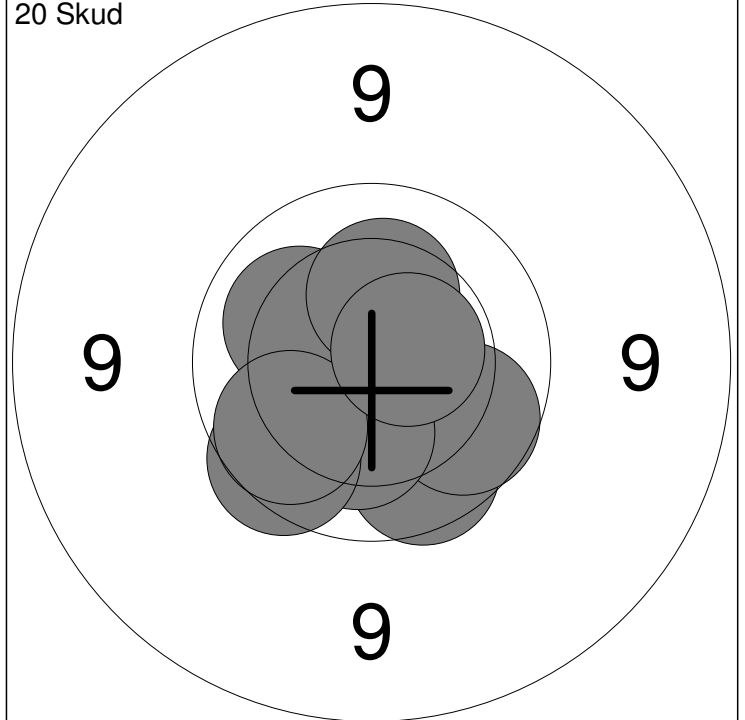
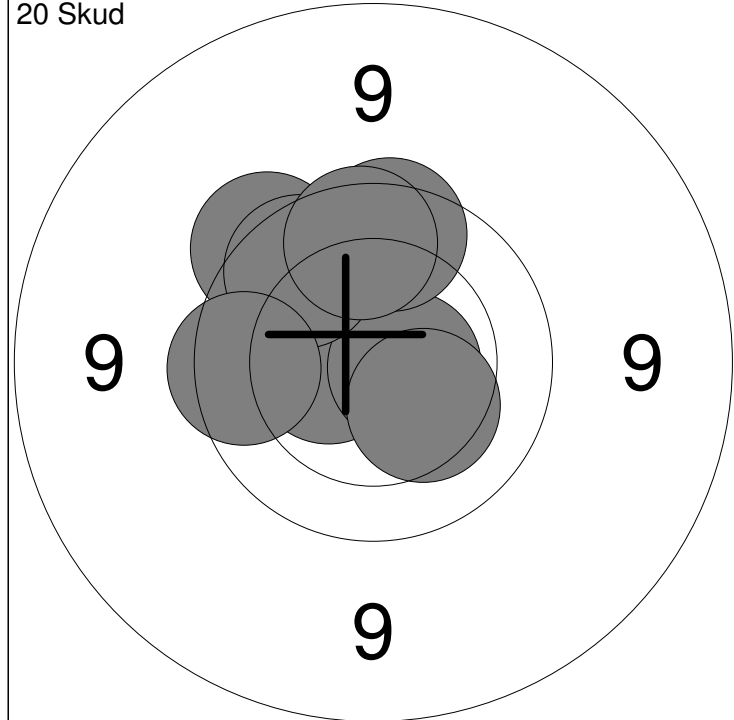

1: 10.3 ↗	6: 9.8 ↑	Serie	95
2: 10.1 ←	7: 9.9 ↗		
3: 10.5x ←	8: 9.8 ↑	Total	95
4: 9.7 ↗	9: 9.8 ←		
5: 10.6x →	10: 10.3 ↓		

11: 10.6x ↗	16: 10.1 ↙	Serie	96
12: 10.5x ↓	17: 9.8 ↙		
13: 9.9 ↓	18: 10.3 ↑	Total	191
14: 9.9 →	19: 9.9 ↙		
15: 10.2 ↓	20: 10.6x →		

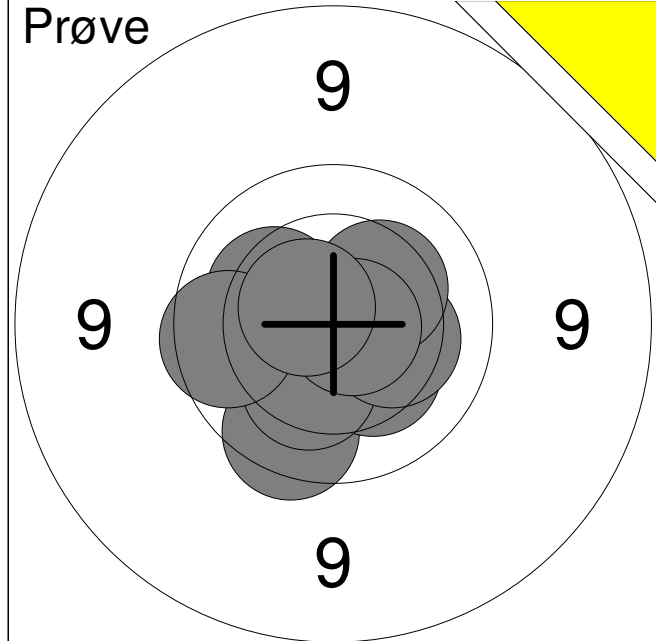

1:	9.8	↘
2:	10.2	↗
3:	10.3	↘
4:	10.3	↘
5:	10.3	↗
6:	10.3	↗
7:	9.9	←
8:	10.7x	→
9:	10.6x	↗
<b>Serie</b>		<b>88</b>
<b>Total</b>		<b>0</b>

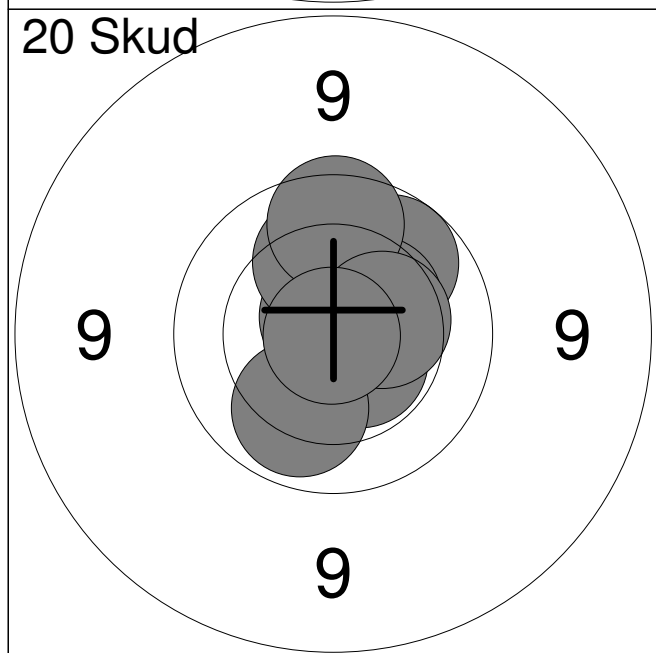

1:	10.5x	↘
2:	10.8x	↗
3:	10.0	↗
4:	10.0	↑
5:	10.1	↑
6:	10.4	↗
7:	9.8	↑
8:	10.4	→
9:	10.1	↘
10:	10.9x	↘
<b>Serie</b>		<b>99</b>
<b>Total</b>		<b>99</b>

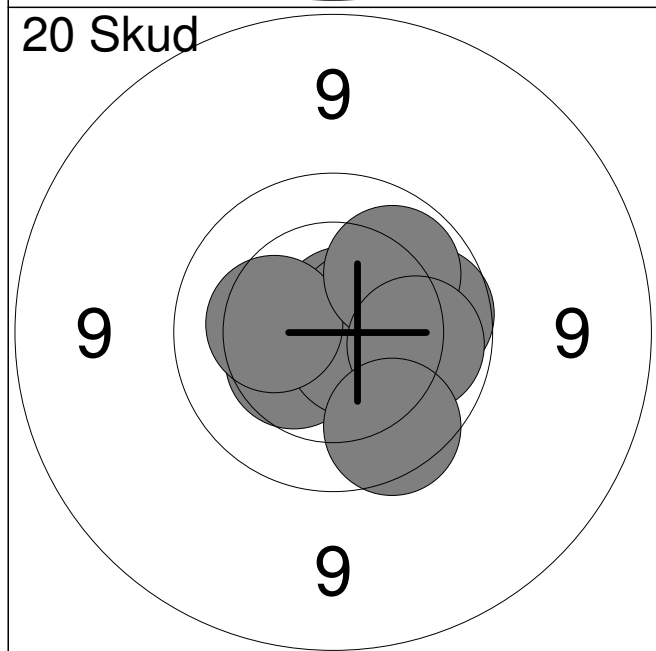

11:	10.6x	↘
12:	9.9	→
13:	10.7x	↗
14:	10.4	↖
15:	10.6x	↗
16:	10.7x	↘
17:	10.3	←
18:	10.0	↗
19:	10.0	→
20:	9.8	↘
<b>Serie</b>		<b>98</b>
<b>Total</b>		<b>197</b>

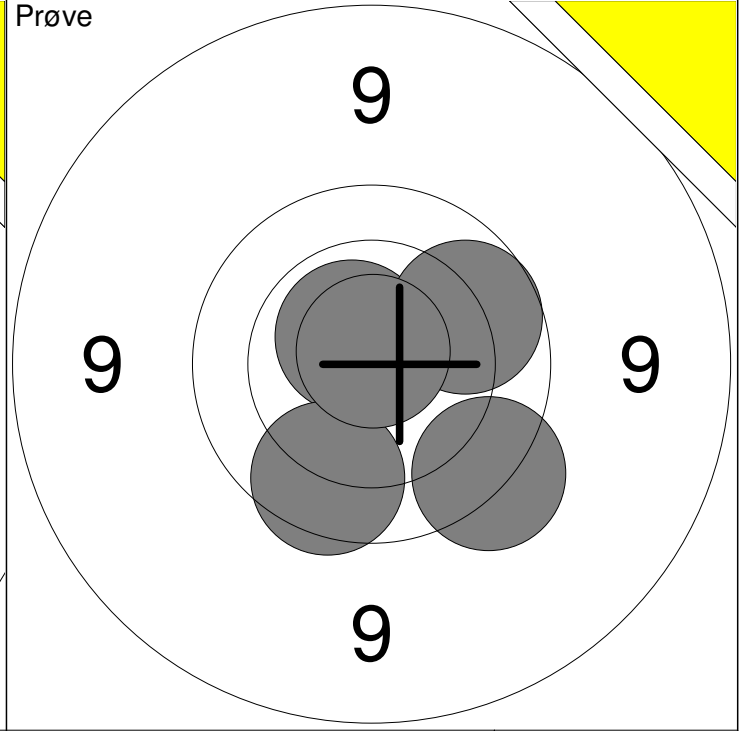
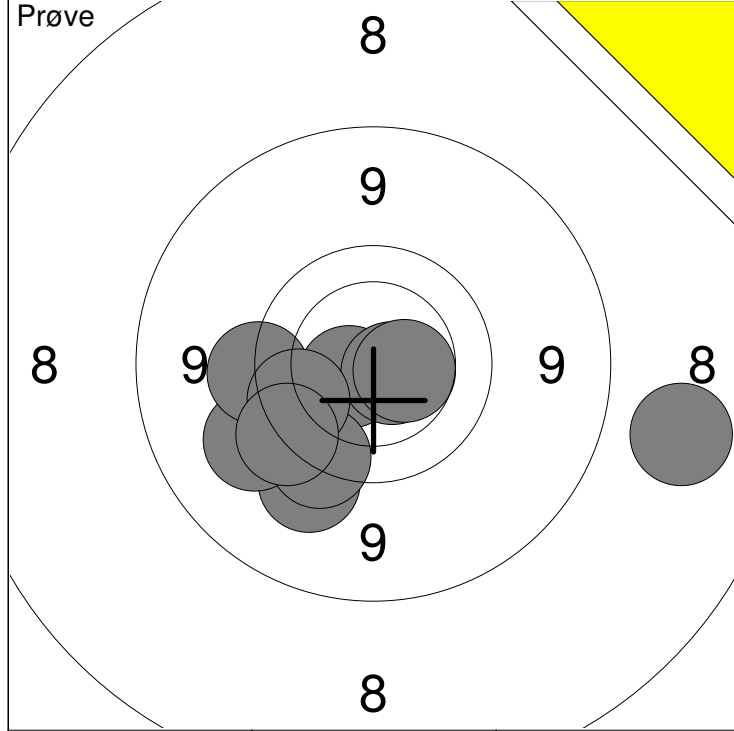

1: 8.2 →	6: 9.5 ←	Serie	92
2: 10.5x ↙	7: 9.6 ↘		
3: 9.4 ↘	8: 9.8 ←	Total	0
4: 9.3 ↙	9: 10.5 →		
5: 10.6x →	10: 9.6 ↙		

11: 10.6x ↖	Serie	47
12: 9.9 →		
13: 9.8 ↘	Total	0
14: 9.6 ↘		
15: 10.8x ↑		

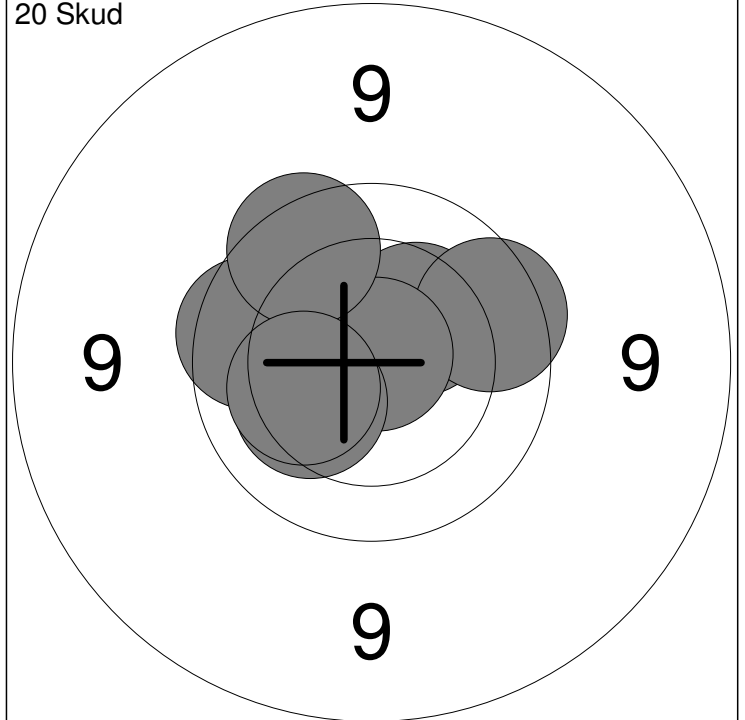
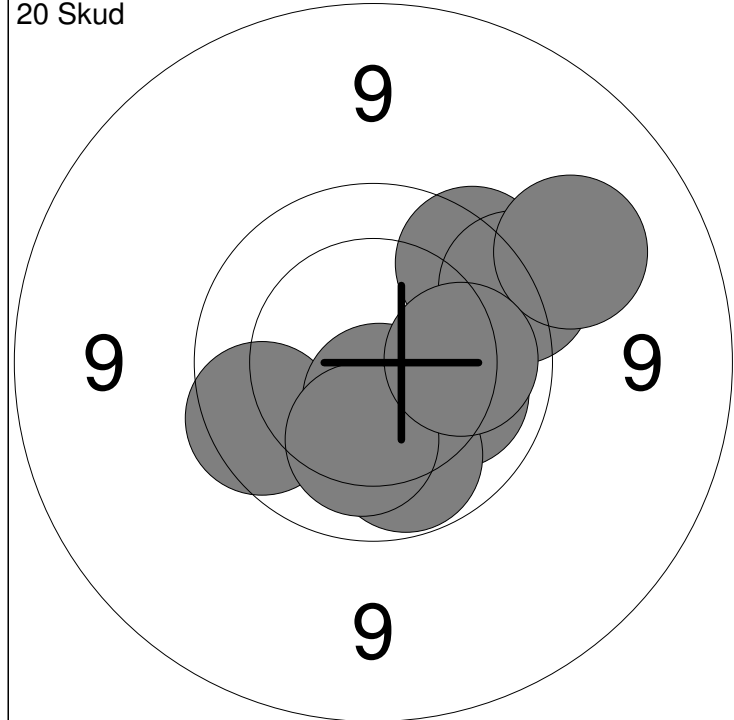

1: 10.3 ↓	6: 10.0 ↓	Serie	96
2: 9.8 ↙	7: 9.6 →		
3: 10.1 →	8: 9.3 →	Total	96
4: 9.7 ↗	9: 10.2 ↓		
5: 10.6x ↓	10: 10.1 →		

11: 10.3 ↗	16: 9.8 ←	Serie	97
12: 9.8 →	17: 10.9x ↗		
13: 10.2 ←	18: 10.2 ↙	Total	193
14: 10.0 ←	19: 9.8 ↖		
15: 10.1 ↙	20: 10.2 ↙		

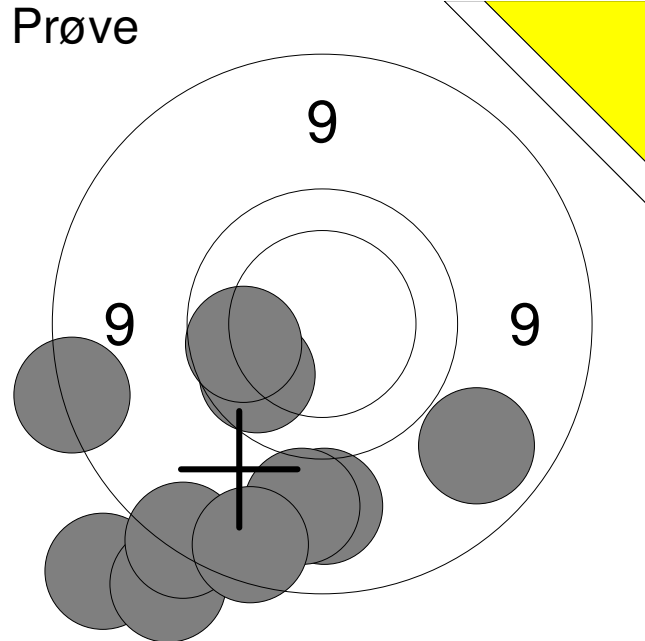
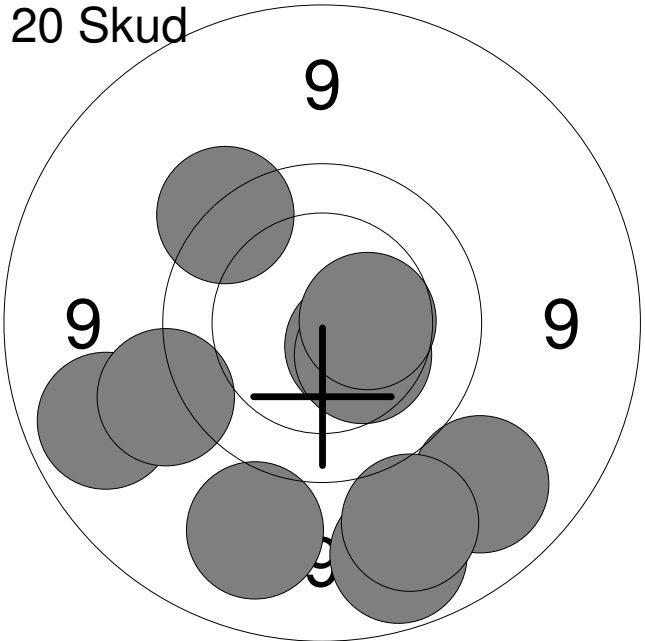
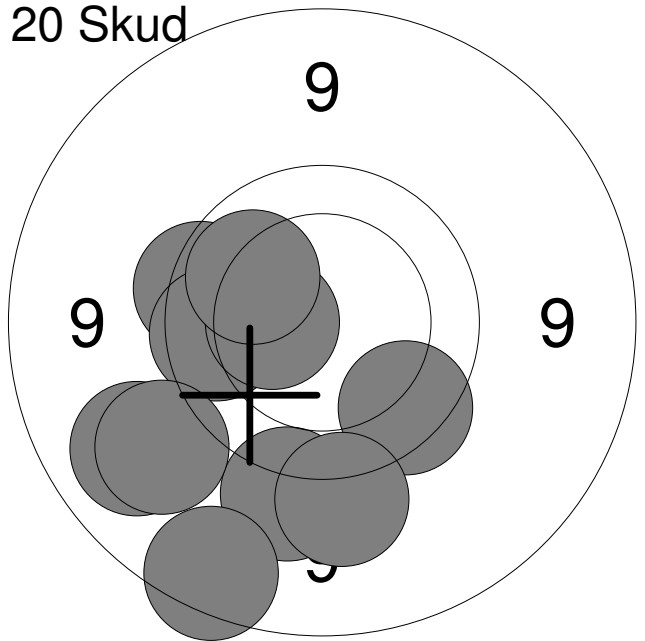

Hold <b>49</b>	Skive <b>9</b>	<b>Lars P M Jakobsen</b>		
Aalborg		Vilsted Skytteforening		VÅ1
		Nordjysk mesterskab 2018	Aalborg Skyttekreds	
Prøve		1:	9.8	↓
		2:	9.9	↓
		3:	10.7x	↗
		4:	10.3	↙
		5:	10.8x	←
		Serie	48	
		Total	0	
20 Skud		1:	9.8	←
		2:	10.2	←
		3:	10.6x	↗
		4:	10.8x	↗
		5:	10.1	←
		6:	10.3	←
		7:	10.9x	↗
		8:	10.4	↓
		9:	10.6x	↘
		10:	10.8x	↑
		Serie	99	
		Total	99	
20 Skud		11:	10.4	↓
		12:	10.2	↙
		13:	10.0	↓
		14:	10.6x	↘
		15:	10.2	↙
		16:	9.8	←
		17:	10.1	↙
		18:	10.1	↘
		19:	10.4	↘
		20:	10.7x	↗
		Serie	99	
		Total	198	

Hold <b>49</b>	Skive <b>10</b>	<b>Arne Jacobsen</b>		
Aalborg		Mou og Omegns Skytteforening		FRI
		Nordjysk mesterskab 2018	Aalborg Skyttekreds	
<b>Prøve</b> 		1: 8.7		←
		2: 9.1		↘
		3: 8.4		↘
		4: 8.5		↘
		5: 9.2		↓
		6: 8.7		↘
		7: 9.9		←
		8: 9.2		↓
		9: 8.9		↘
		10: 9.9		←
		<b>Serie</b>	<b>85</b>	
		<b>Total</b>	<b>0</b>	
<b>20 Skud</b> 		1: 9.2		↓
		2: 9.0		↘
		3: 9.1		↘
		4: 9.2		↘
		5: 10.5x		↘
		6: 10.4		↘
		7: 9.0		←
		8: 10.4		→
		9: 9.4		←
		10: 9.6		↗
		<b>Serie</b>	<b>93</b>	
		<b>Total</b>	<b>93</b>	
<b>20 Skud</b> 		11: 9.1		←
		12: 9.4		↓
		13: 9.7		←
		14: 9.8		←
		15: 8.8		↘
		16: 10.4		←
		17: 9.8		↘
		18: 9.4		↓
		19: 10.0		↗
		20: 9.2		↘
		<b>Serie</b>	<b>91</b>	
		<b>Total</b>	<b>184</b>	

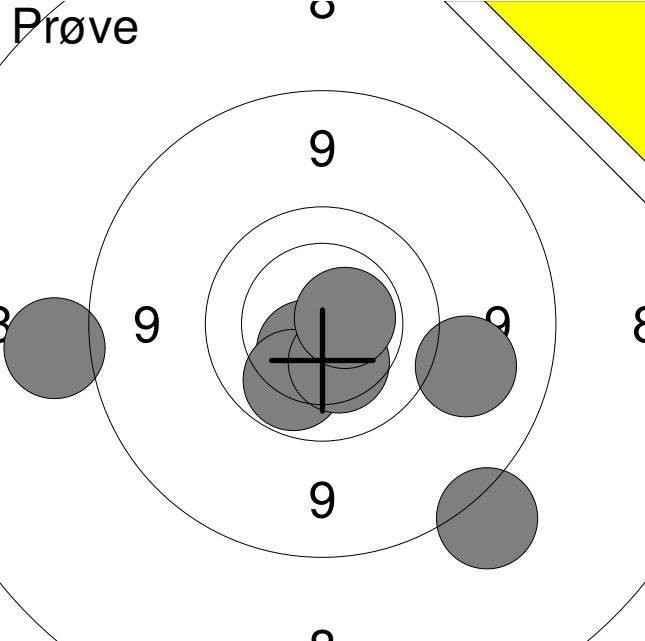
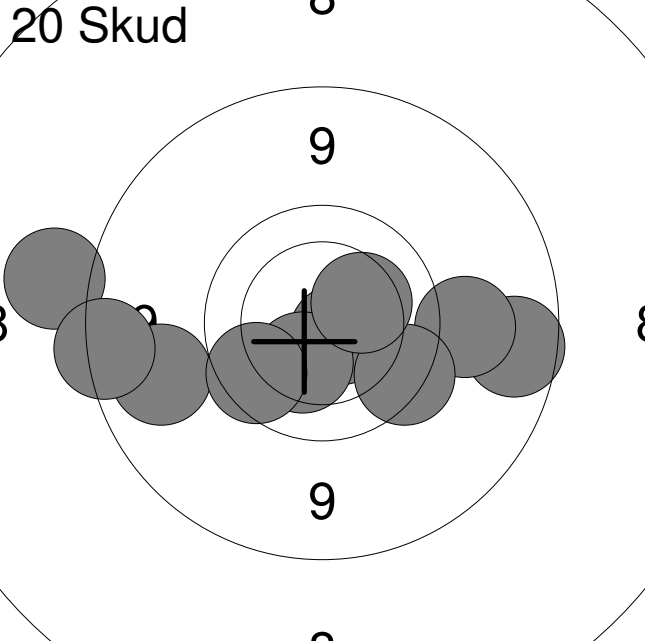
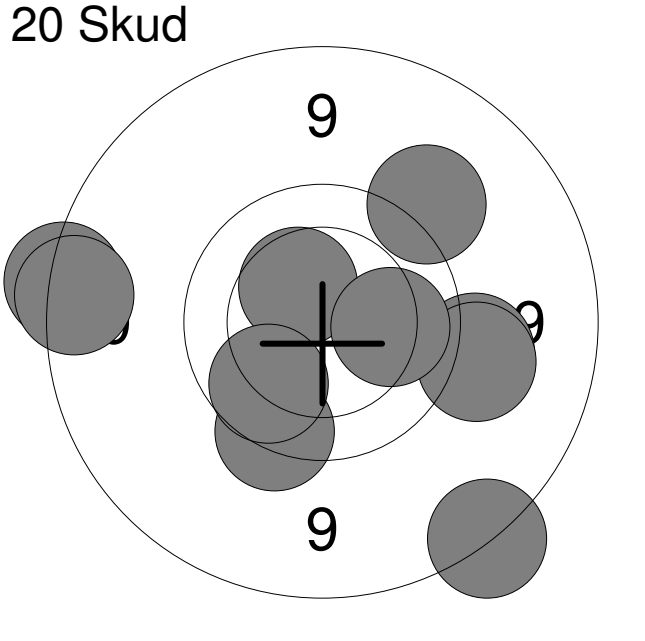
Hold	Skive	Klaus Meulengracht		
49	11	Mou og Omegns Skytteforening		VÅ3
Aalborg		Nordjysk mesterskab 2018		Aalborg Skyttekreds
<b>Prøve</b> 		1: 8.5 ← 2: 10.5x ↓ 3: 9.2 → 4: 8.6 ↓ 5: 10.0 ↓ 6: 10.3 ↓ 7: 10.6x →		
		Serie		65
		Total		0
<b>20 Skud</b> 		1: 9.1 ← 2: 10.6x ↓ 3: 8.5 ← 4: 8.9 → 5: 9.3 → 6: 9.7 ↓ 7: 10.3 ↓ 8: 10.3 ↗ 9: 8.8 ← 10: 9.8 ↙		
		Serie		90
		Total		90
<b>20 Skud</b> 		11: 9.4 → 12: 9.7 ↓ 13: 8.7 ← 14: 8.8 ← 15: 8.7 ↓ 16: 10.4 ↗ 17: 9.9 ↓ 18: 9.4 → 19: 9.4 ↗ 20: 10.1 →		
		Serie		89
		Total		179

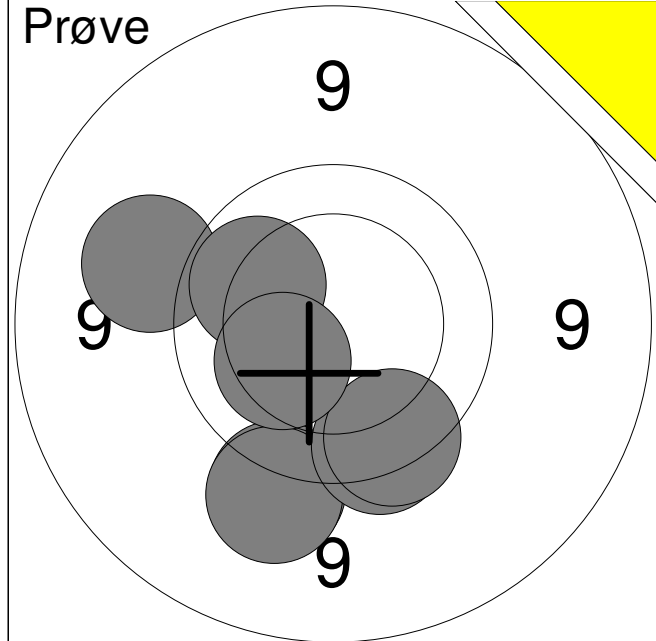

1:	9.4	↓
2:	9.4	↓
3:	9.7	↓
4:	9.7	↓
5:	9.3	↖
6:	10.0	↗
7:	10.3	↙
<b>Serie</b>		<b>65</b>
<b>Total</b>		<b>0</b>

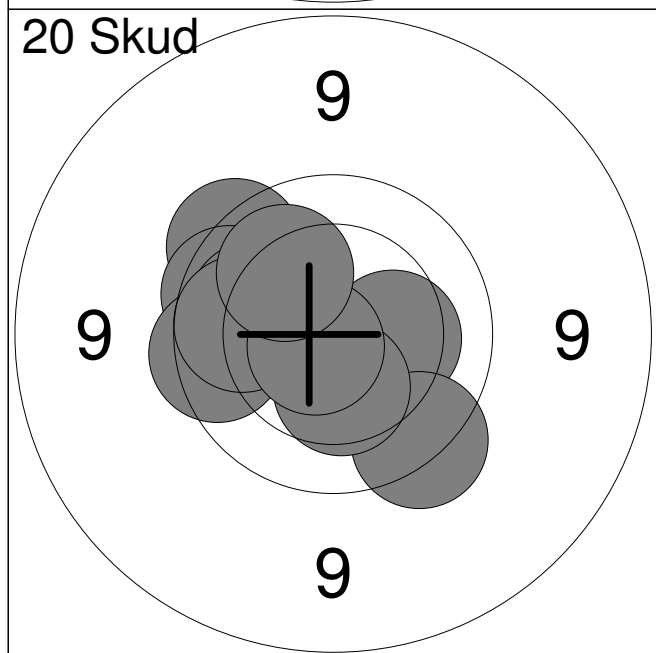

1:	10.3	→
2:	9.7	↗
3:	9.8	↖
4:	9.8	←
5:	10.1	↖
6:	9.7	↓
7:	10.4	↓
8:	9.9	←
9:	10.7x	↙
10:	10.1	↗
<b>Serie</b>		<b>95</b>
<b>Total</b>		<b>95</b>

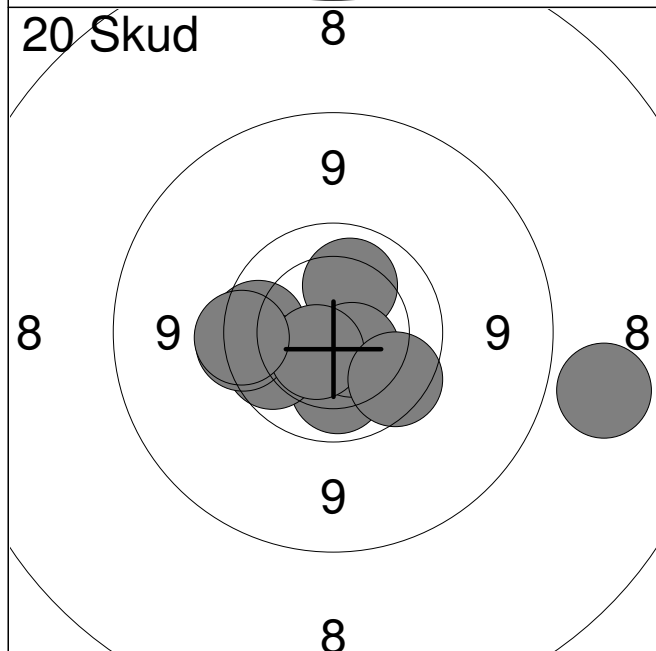

11:	10.2	↗
12:	10.1	↓
13:	9.8	←
14:	9.9	↖
15:	10.5x	↓
16:	9.7	←
17:	8.3	→
18:	10.5x	↙
19:	9.7	←
20:	9.8	↙
<b>Serie</b>		<b>93</b>
<b>Total</b>		<b>188</b>

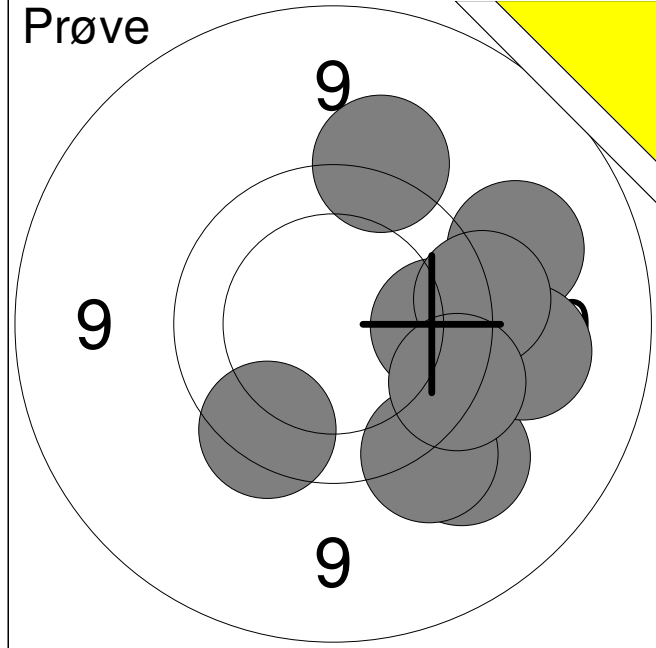

1:	9.4	↘
2:	9.3	→
3:	9.7	↘
4:	9.5	↘
5:	9.9	→
6:	9.3	→
7:	9.6	→
8:	9.7	↘
9:	9.5	↗
<b>Serie</b>		<b>81</b>
<b>Total</b>		<b>0</b>

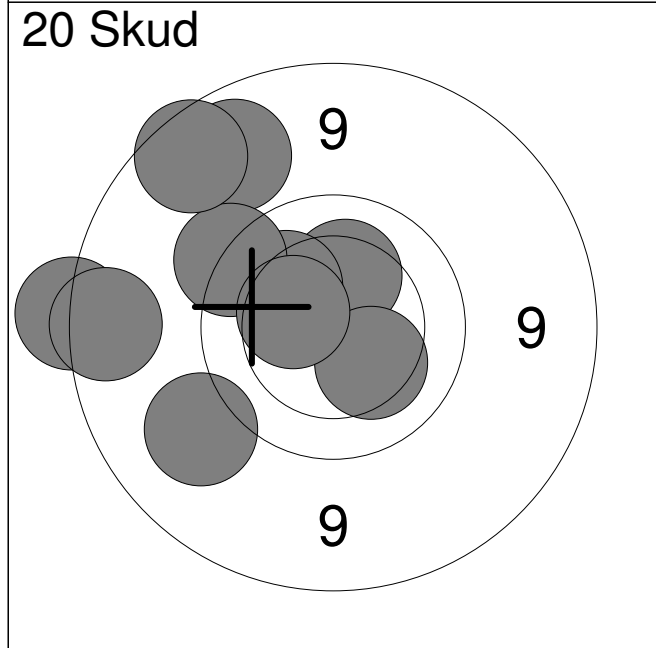

1:	9.0	↗
2:	10.3	↗
3:	8.7	←
4:	10.1	↗
5:	9.6	↗
6:	8.9	←
7:	8.9	↗
8:	9.3	↘
9:	10.3	↘
10:	10.4	←
<b>Serie</b>		<b>91</b>
<b>Total</b>		<b>91</b>

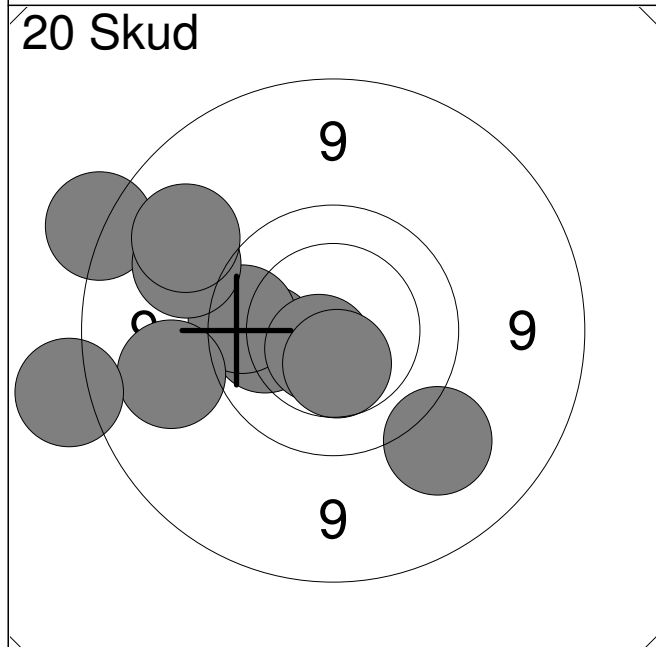

11:	10.0	←
12:	9.8	←
13:	10.6x	↘
14:	9.3	↘
15:	8.6	↗
16:	9.2	←
17:	8.6	←
18:	9.2	↗
19:	10.5	↘
20:	9.1	↗
<b>Serie</b>		<b>91</b>
<b>Total</b>		<b>182</b>

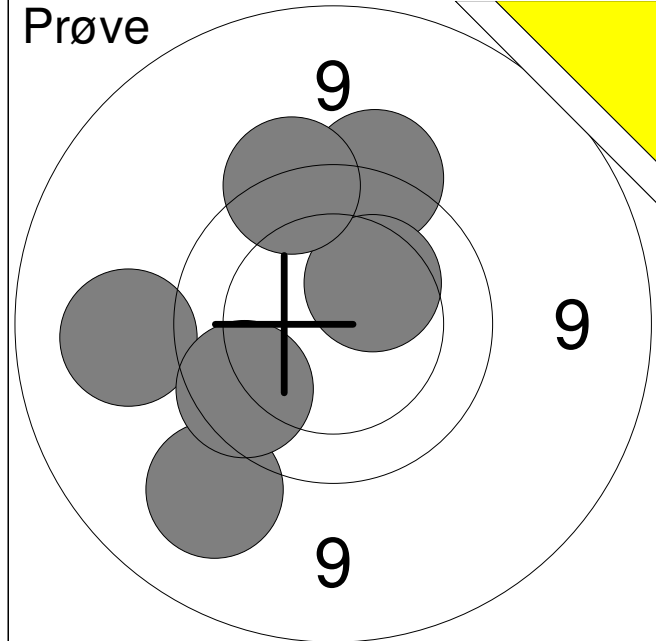

1:	9.6	↑
2:	9.2	←
3:	10.3	↗
4:	9.6	↑
5:	9.2	↓
6:	9.8	↙
<b>Serie</b>		<b>55</b>
<b>Total</b>		<b>0</b>

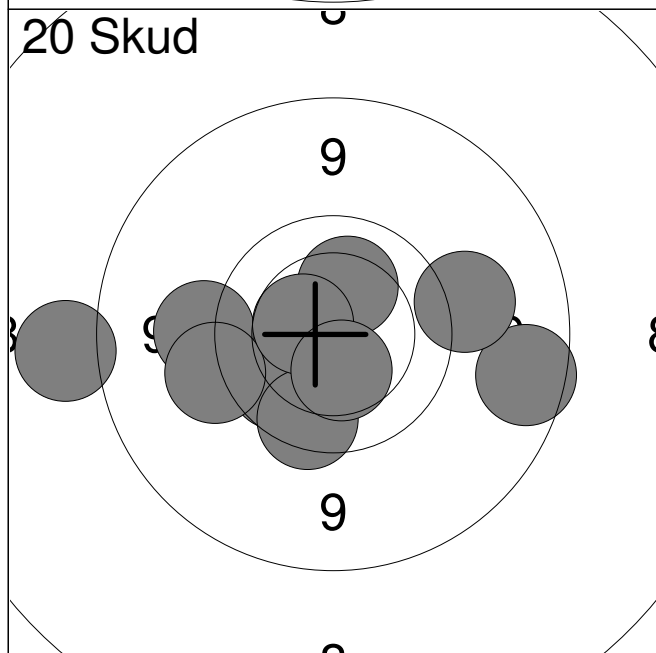

1:	9.9	↙
2:	8.9	→
3:	10.2	↑
4:	9.4	→
5:	9.4	←
6:	9.8	↓
7:	9.5	←
8:	8.5	←
9:	10.5	↙
10:	10.4	↓
<b>Serie</b>		<b>91</b>
<b>Total</b>		<b>91</b>

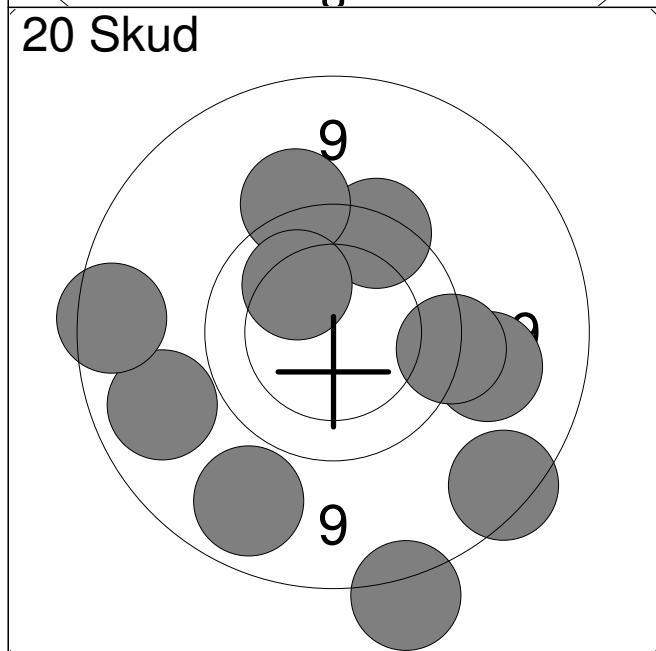

11:	9.3	→
12:	9.1	←
13:	8.8	↘
14:	9.6	→
15:	9.0	↓
16:	8.8	←
17:	9.7	↑
18:	8.6	↓
19:	9.5	↑
20:	10.1	↗
<b>Serie</b>		<b>88</b>
<b>Total</b>		<b>179</b>

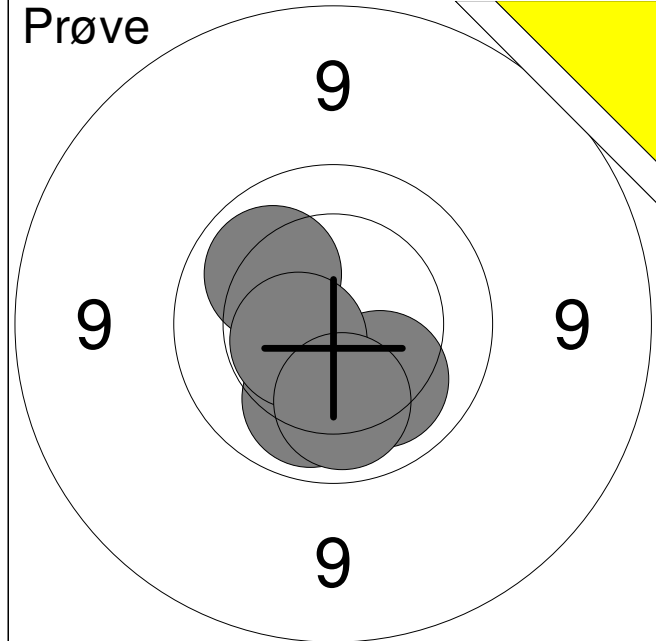

1:	10.1	↗
2:	10.1	↓
3:	10.2	↘
4:	10.5x	↖
5:	10.1	↓
<b>Serie</b>		<b>50</b>
<b>Total</b>		<b>0</b>

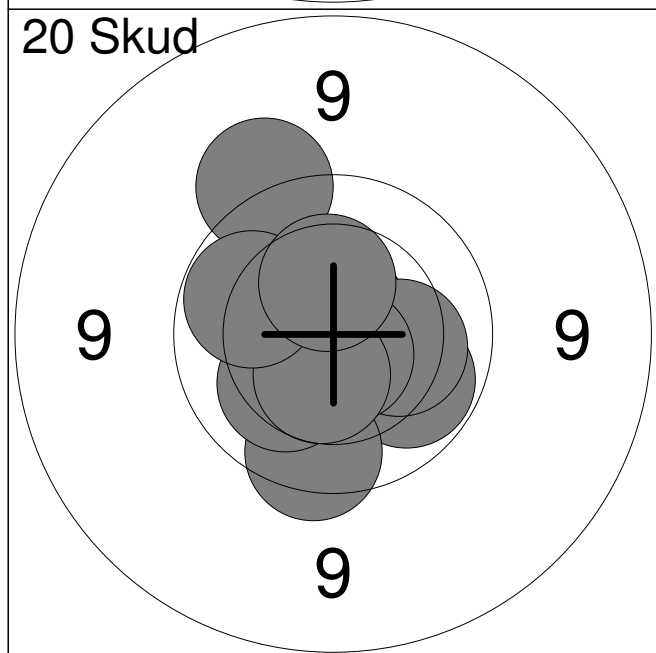

1:	10.7x	↑
2:	10.0	↘
3:	9.8	↓
4:	10.2	↖
5:	10.2	→
6:	10.7x	↘
7:	9.5	↑
8:	10.5	↓
9:	10.0	↖
10:	10.4	↑
<b>Serie</b>		<b>98</b>
<b>Total</b>		<b>98</b>

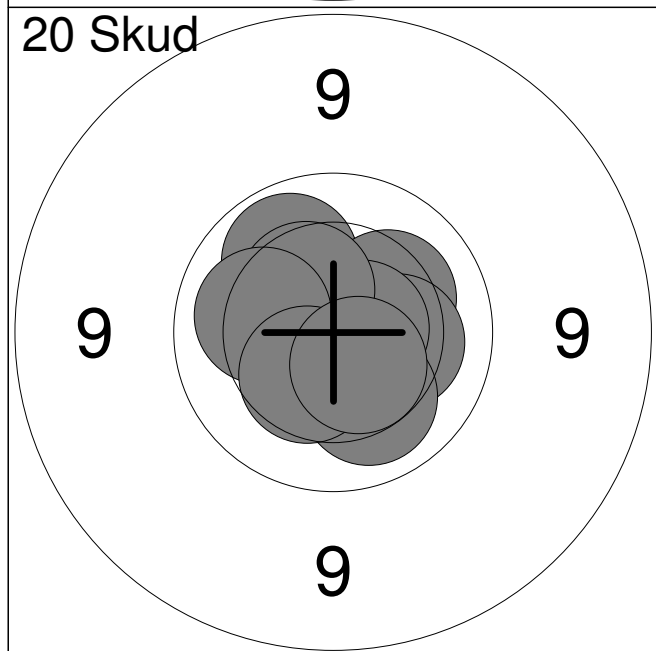

11:	10.0	↗
12:	10.8x	↑
13:	10.2	↗
14:	10.2	→
15:	10.6x	→
16:	10.1	↘
17:	10.4	↑
18:	10.1	↖
19:	10.4	↘
20:	10.5x	↘
<b>Serie</b>		<b>100</b>
<b>Total</b>		<b>198</b>

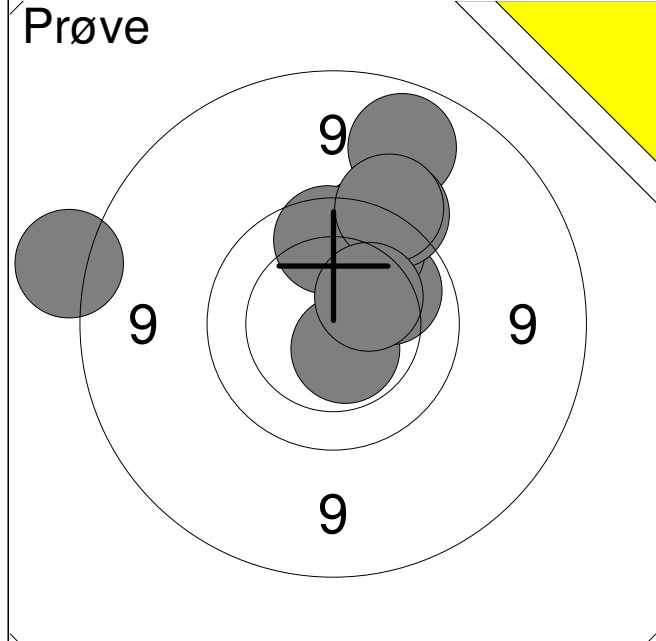

1:	8.6	←
2:	9.0	↑
3:	10.6x	↓
4:	10.1	↗
5:	9.9	↑
6:	9.7	↑
7:	9.5	↑
8:	9.9	↑
9:	9.5	↑
10:	10.3	↗
<b>Serie</b>		<b>92</b>
<b>Total</b>		<b>0</b>

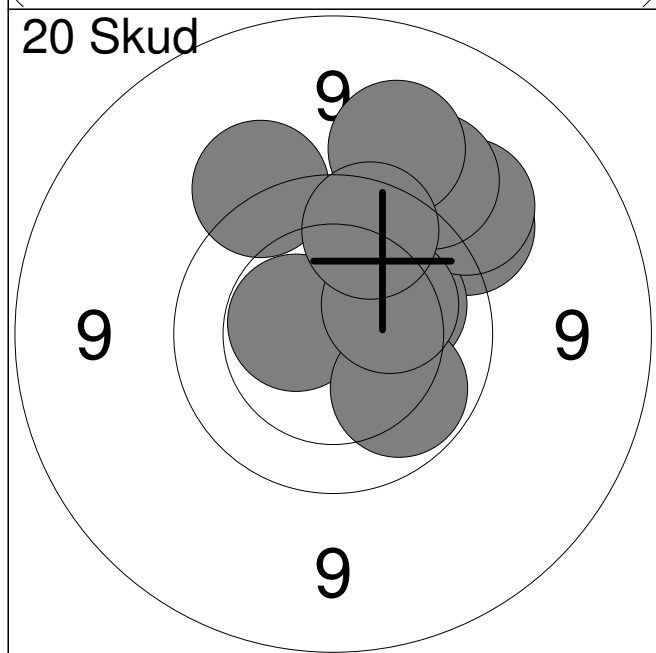

1:	9.4	↗
2:	10.2	↗
3:	9.4	↗
4:	9.4	↑
5:	9.5	↑
6:	9.3	↑
7:	10.5x	←
8:	10.0	↓
9:	10.2	↗
10:	9.8	↑
<b>Serie</b>		<b>94</b>
<b>Total</b>		<b>94</b>

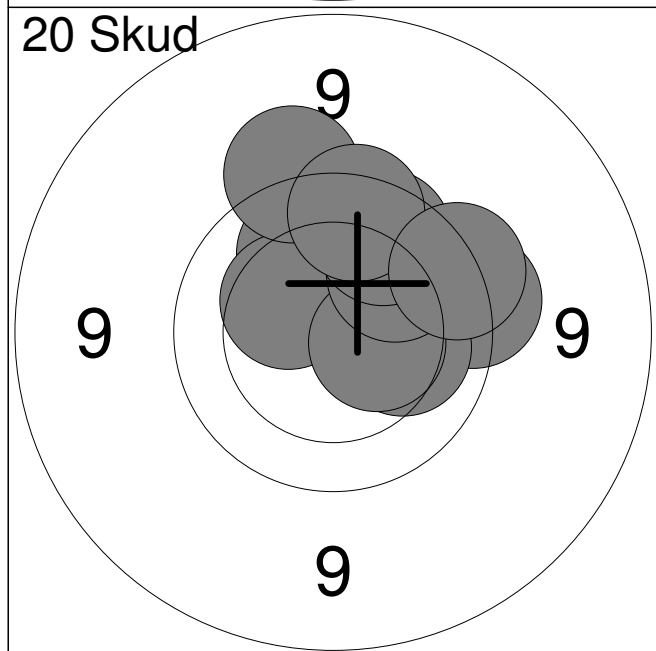

11:	10.0	↑
12:	10.3	↖
13:	9.6	→
14:	10.2	→
15:	9.5	↑
16:	10.5	→
17:	10.0	↗
18:	9.8	↑
19:	9.8	↑
20:	9.7	↗
<b>Serie</b>		<b>95</b>
<b>Total</b>		<b>189</b>



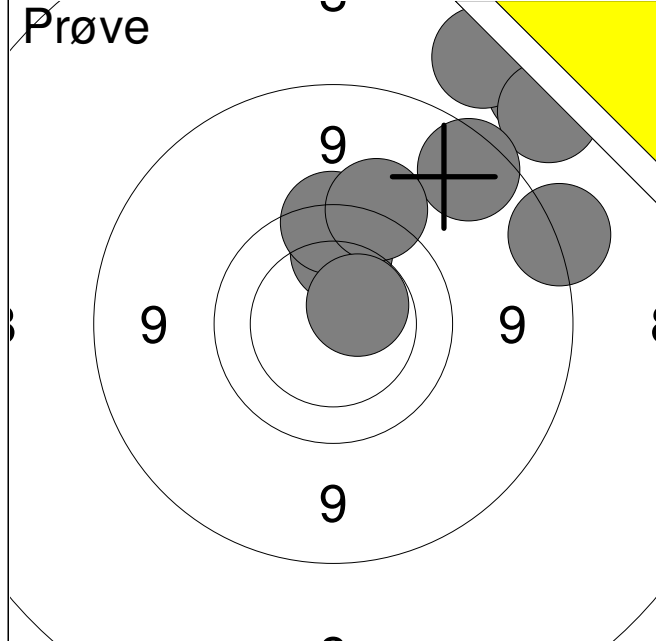

1:	8.7	➔
2:	8.2	↗
3:	8.3	↗
4:	8.3	↗
5:	8.3	↗
6:	8.9	↗
7:	9.9	↑
8:	9.7	↑
9:	9.5	↗
10:	10.5x	↗
<b>Serie</b>		<b>85</b>
<b>Total</b>		<b>0</b>

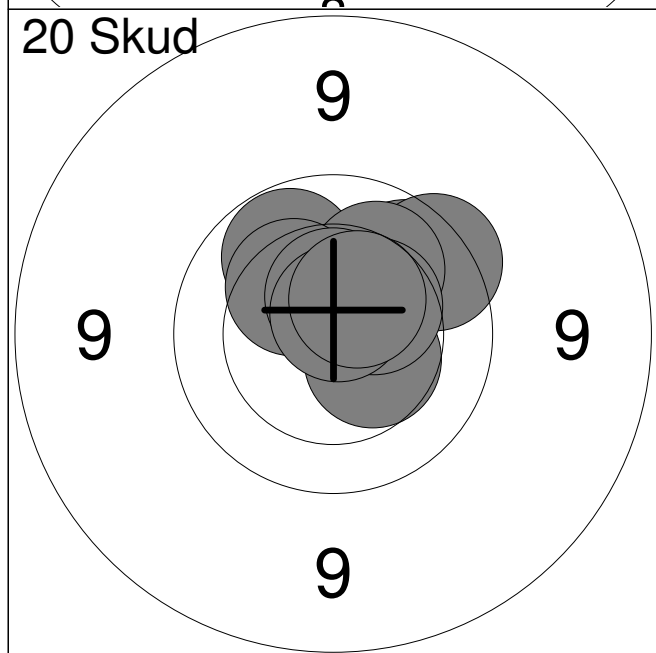

1:	9.9	↗
2:	10.0	↖
3:	10.4	↘
4:	9.7	↗
5:	10.1	↗
6:	10.3	↖
7:	10.4	↗
8:	10.5x	↑
9:	10.7x	↑
10:	10.5	↗
<b>Serie</b>		<b>98</b>
<b>Total</b>		<b>98</b>

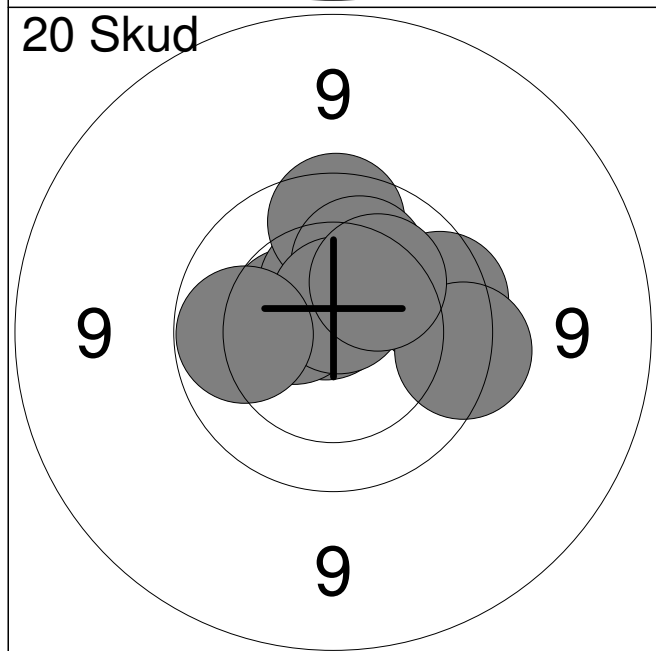

11:	10.7x	↑
12:	10.5	↖
13:	9.8	➔
14:	10.4	↑
15:	9.8	↑
16:	10.1	↗
17:	10.6x	↑
18:	10.0	↖
19:	9.7	➔
20:	10.2	↗
<b>Serie</b>		<b>97</b>
<b>Total</b>		<b>195</b>

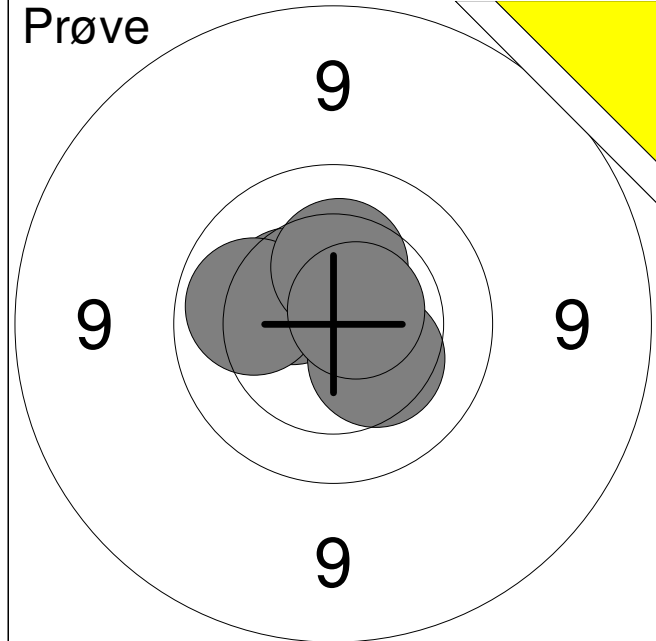

1:	10.4	↗
2:	10.1	↖
3:	10.3	↘
4:	10.3	↑
5:	10.7x	↗
<b>Serie</b>		<b>50</b>
<b>Total</b>		<b>0</b>

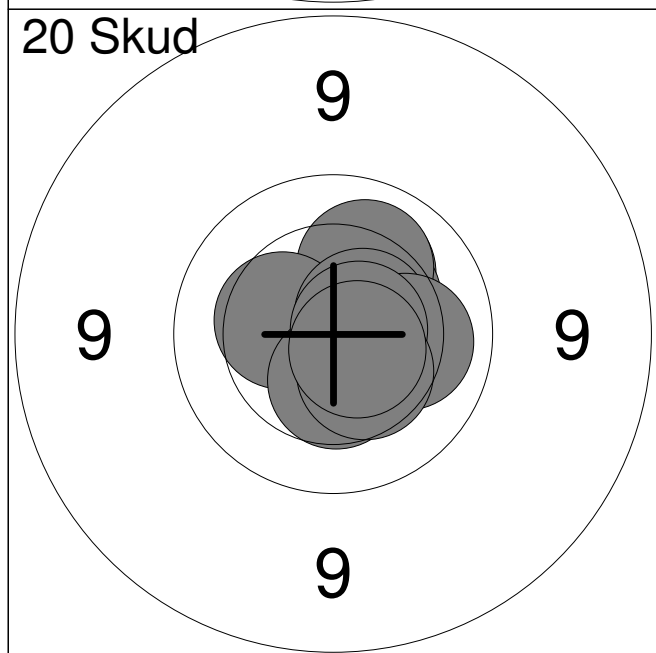

1:	10.2	↗
2:	10.4	↗
3:	10.1	↗
4:	10.4	↖
5:	10.6x	↗
6:	10.4	↓
7:	10.2	→
8:	10.7x	→
9:	10.4	↘
10:	10.6x	↘
<b>Serie</b>		<b>100</b>
<b>Total</b>		<b>100</b>

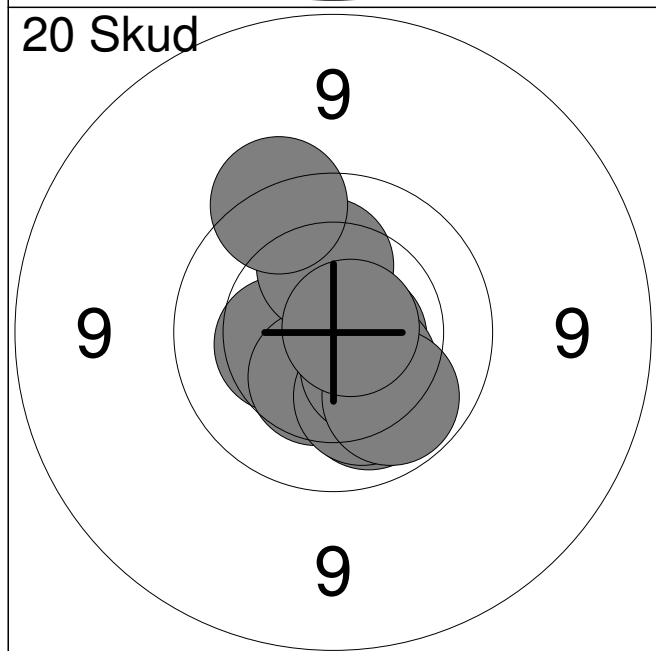

11:	10.1	↘
12:	10.4	↖
13:	10.4	↘
14:	10.2	↘
15:	10.7x	→
16:	10.4	↘
17:	10.0	↘
18:	10.2	↑
19:	9.7	↗
20:	10.8x	→
<b>Serie</b>		<b>99</b>
<b>Total</b>		<b>199</b>

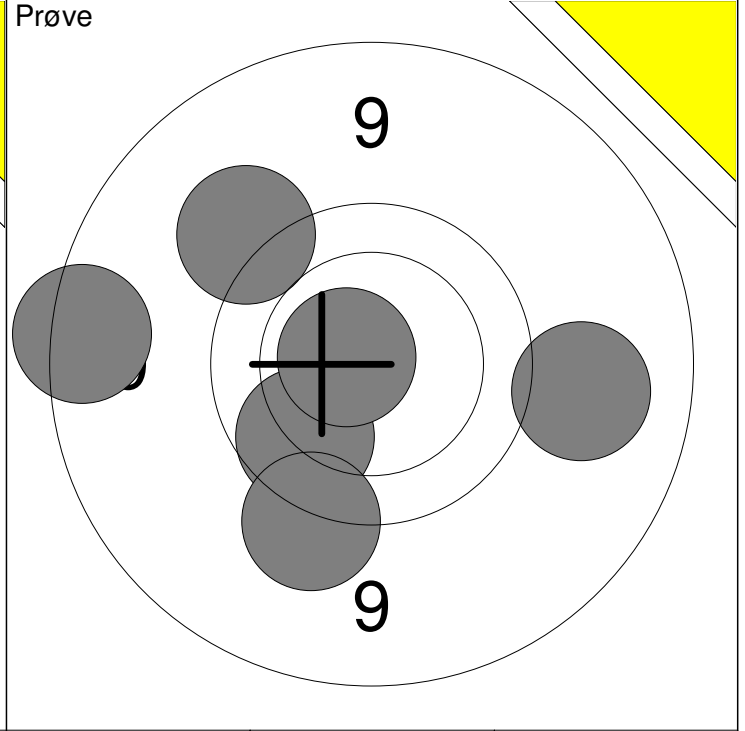
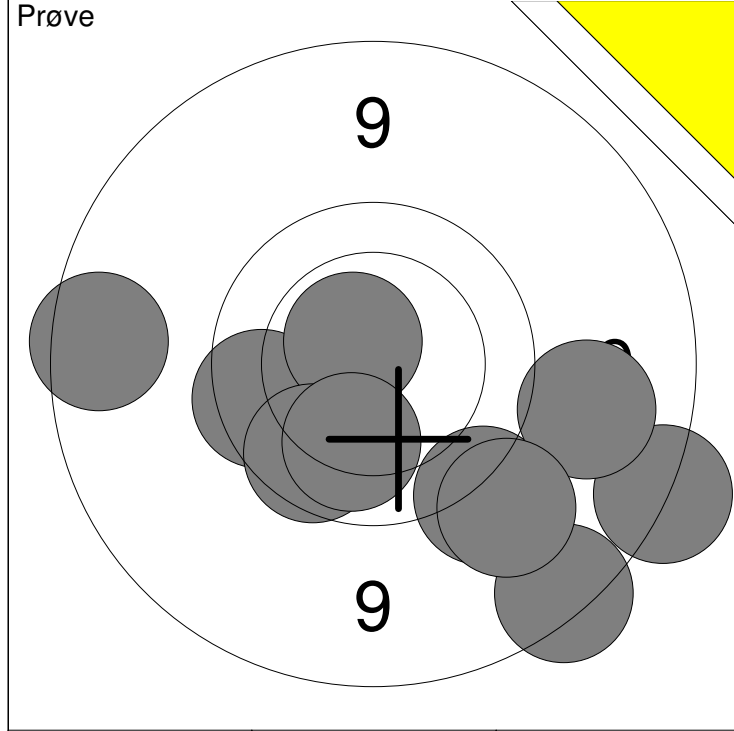

1: 8.8 ↘	6: 9.8 ↘	Serie 89
2: 9.8 ←	7: 8.7 ↗	
3: 10.6x ↗	8: 10.1 ↘	Total 0
4: 8.9 ←	9: 9.2 ↗	
5: 9.5 ↘	10: 9.3 ↘	

11: 9.9 ↘	16: 10.7x ←	Serie 54
12: 9.5 ↘	13: 8.8 ←	
14: 9.4 ↗	15: 9.2 →	Total 0

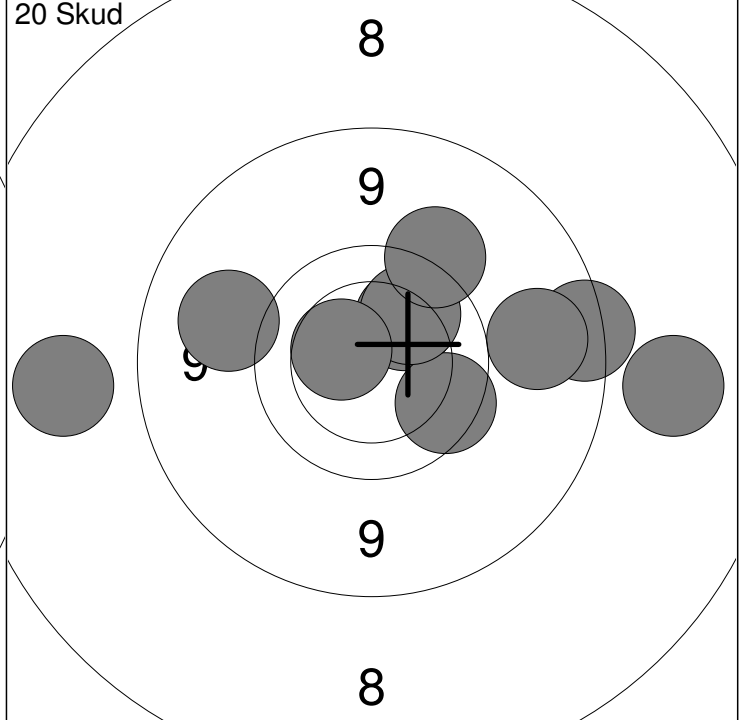
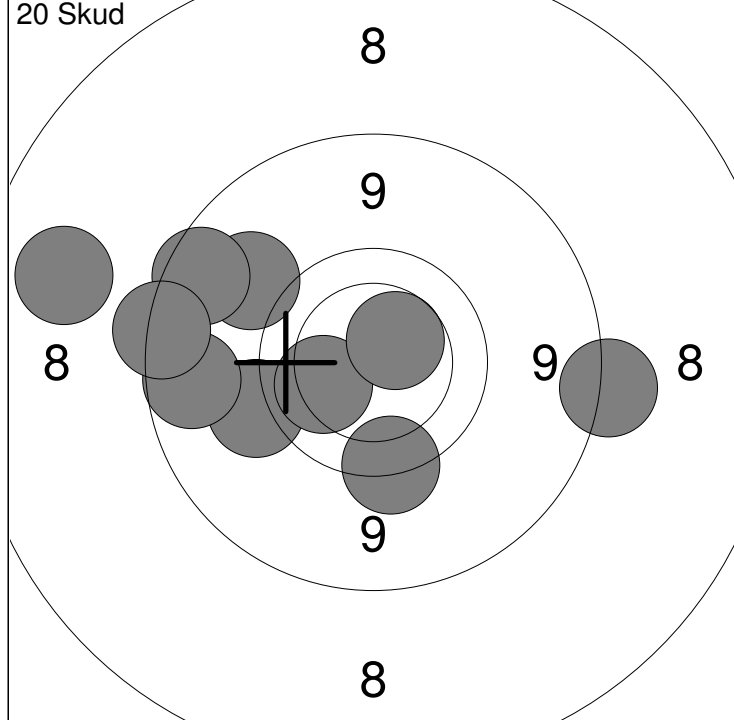

1: 9.4 ←	6: 9.2 ↖	Serie 87
2: 8.9 ←	7: 9.6 ↘	
3: 10.1 ←	8: 8.9 ←	Total 87
4: 8.1 ←	9: 8.8 ←	
5: 8.6 →	10: 10.5 ↗	

11: 10.1 ↗	16: 10.0 ↗	Serie 90
12: 8.8 →	17: 8.3 →	
13: 9.8 ↘	18: 9.5 ↗	Total 177
14: 9.2 ←	19: 9.1 →	
15: 8.3 ←	20: 10.5 ←	

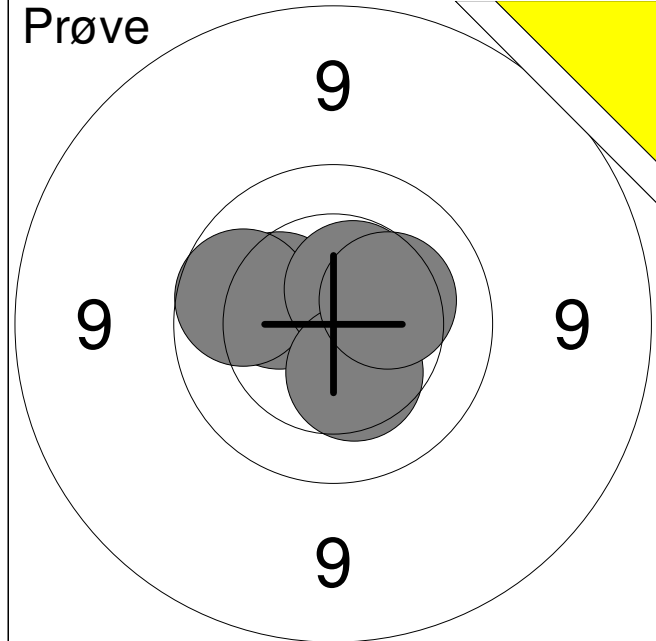

1:	10.3	↖
2:	9.9	↖
3:	10.5x	↗
4:	10.4	↘
5:	10.3	↗
<b>Serie</b>		<b>49</b>
<b>Total</b>		<b>0</b>

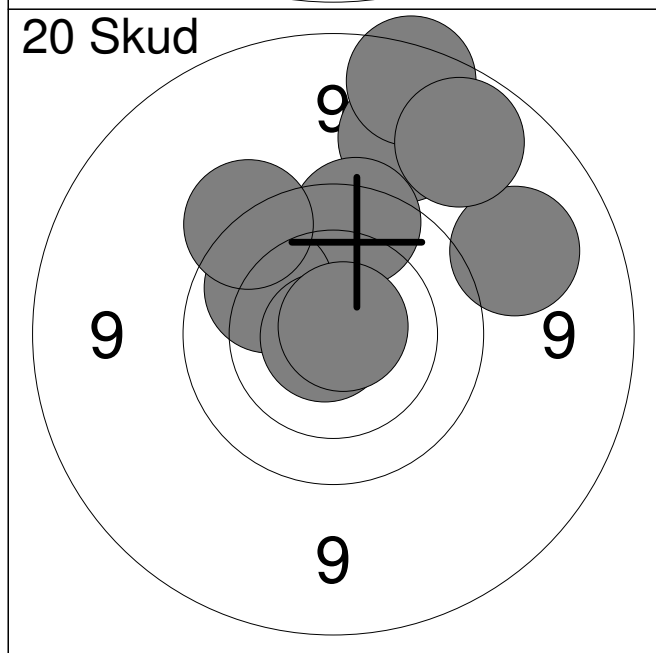

1:	9.1	↗
2:	10.6x	↖
3:	8.8	↗
4:	9.8	↗
5:	10.0	↖
6:	9.2	↗
7:	10.8x	↖
8:	9.0	↗
9:	10.8x	↗
10:	9.6	↖
<b>Serie</b>		<b>93</b>
<b>Total</b>		<b>93</b>

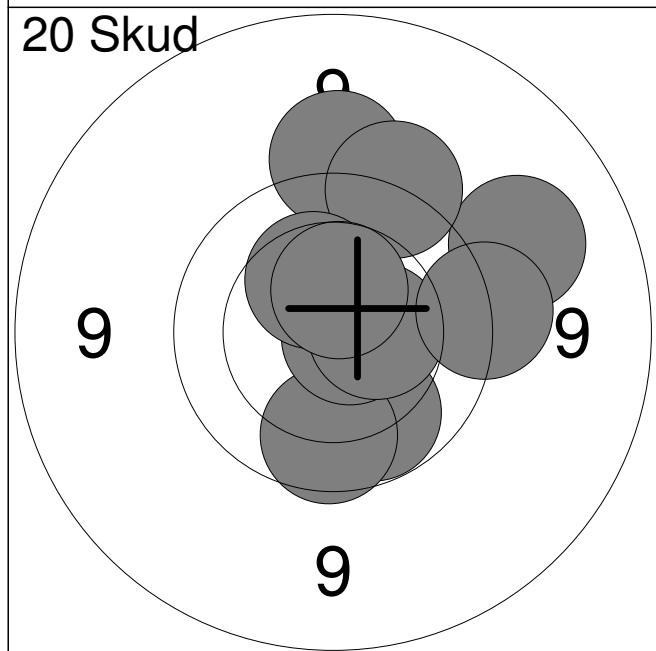

11:	9.4	↗
12:	9.2	↗
13:	10.0	↘
14:	9.5	↗
15:	9.9	↘
16:	10.8x	→
17:	10.3	↗
18:	10.5	→
19:	10.5	↗
20:	9.6	→
<b>Serie</b>		<b>95</b>
<b>Total</b>		<b>188</b>

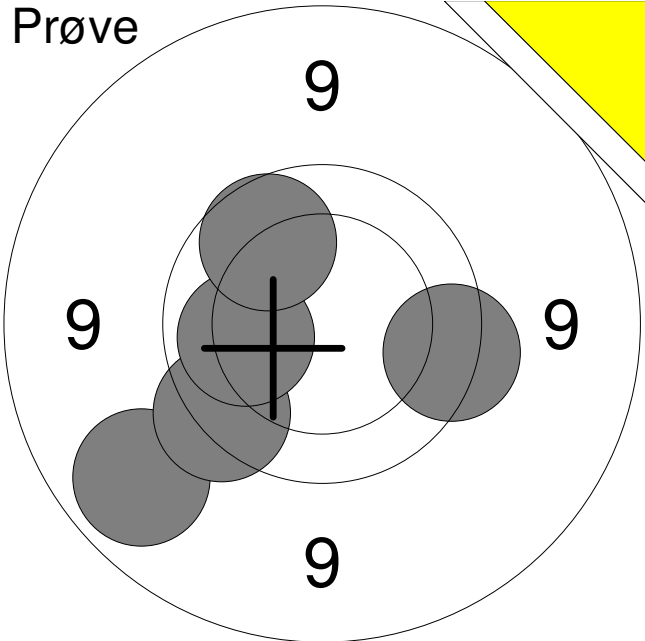
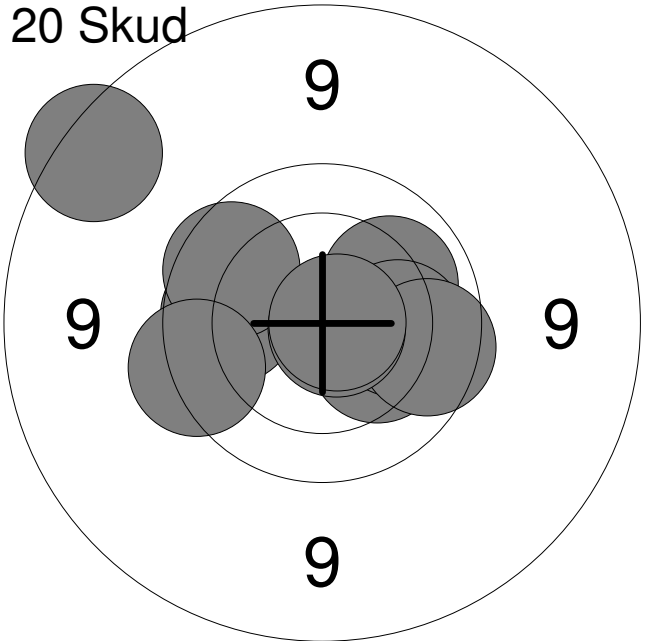
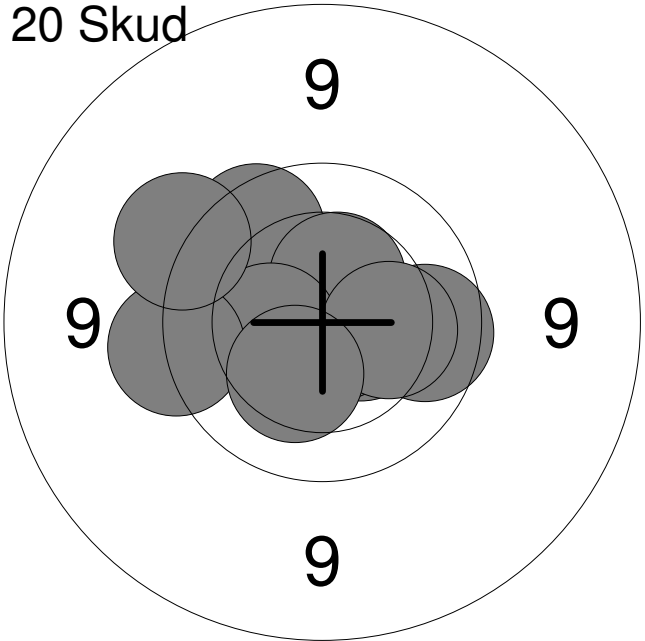
Hold	Skive	Annette Munkbøl		
50	10	Aalborg	Aalborg Skyttekreds	MVS2
Prøve		Nordjysk mesterskab 2018	Aalborg Skyttekreds	
	1:	9.0	↙	
	2:	9.7	↙	
	3:	9.7	→	
	4:	10.1	←	
	5:	9.9	↗	
	Serie			46
Total			0	
	1:	9.9	←	
	2:	10.1	↗	
	3:	10.3	↘	
	4:	10.1	→	
	5:	9.8	→	
	6:	9.9	↗	
	7:	9.7	←	
	8:	8.8	↗	
	9:	10.8x	↘	
	10:	10.8x	→	
	Serie			94
Total			94	
	11:	9.9	→	
	12:	9.8	↗	
	13:	10.5x	→	
	14:	10.8x	↘	
	15:	10.5	↗	
	16:	10.4	←	
	17:	9.6	←	
	18:	9.5	↗	
	19:	10.2	→	
	20:	10.3	↘	
	Serie			96
Total			190	

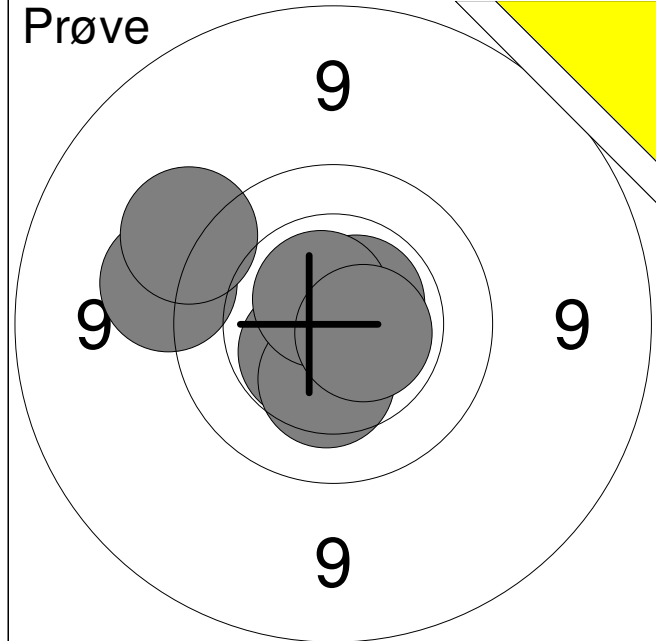

1:	9.5	←
2:	10.5x	↙
3:	10.3	↓
4:	10.6x	↗
5:	9.5	↖
6:	10.6x	↗
7:	10.6x	→
<b>Serie</b>		<b>68</b>
<b>Total</b>		<b>0</b>

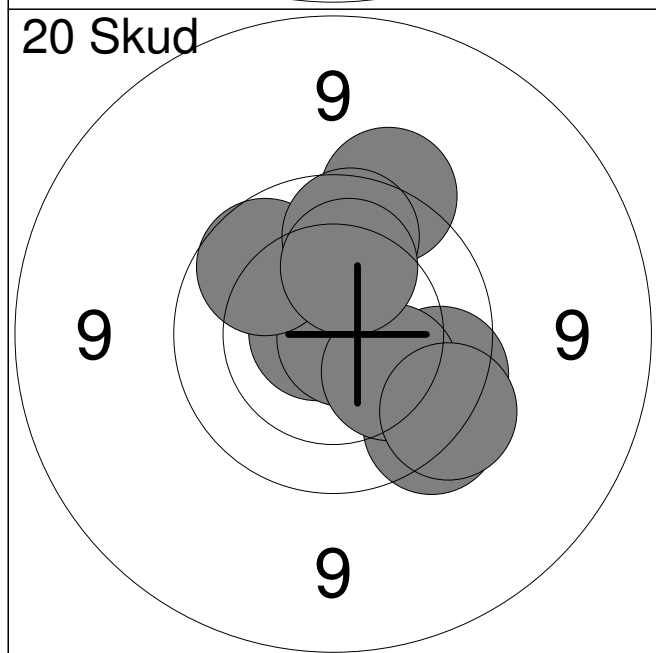

1:	9.7	↘
2:	9.6	↗
3:	10.8x	←
4:	10.8x	→
5:	9.9	↗
6:	9.8	↘
7:	10.2	↘
8:	9.6	↘
9:	9.9	↑
10:	10.2	↑
<b>Serie</b>		<b>94</b>
<b>Total</b>		<b>94</b>

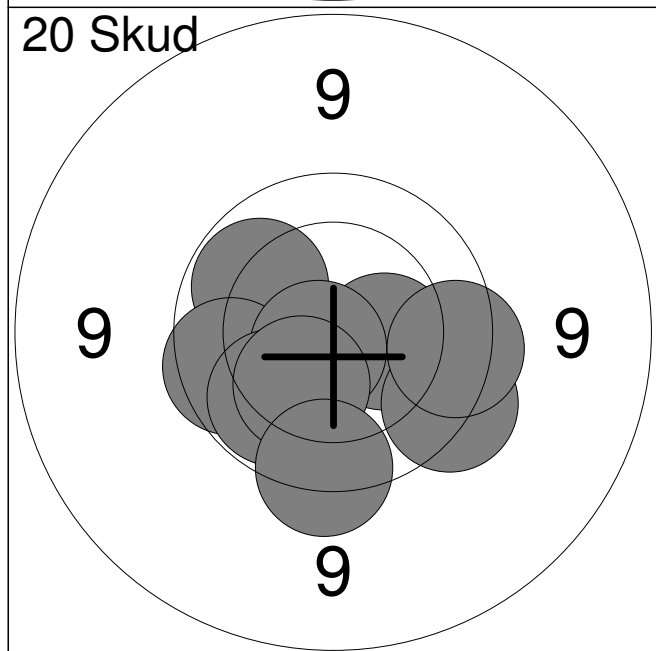

11:	10.4	→
12:	9.7	↘
13:	10.0	↗
14:	9.7	→
15:	9.8	←
16:	10.7x	↘
17:	10.0	↘
18:	10.0	↘
19:	10.3	↘
20:	9.7	↓
<b>Serie</b>		<b>96</b>
<b>Total</b>		<b>190</b>

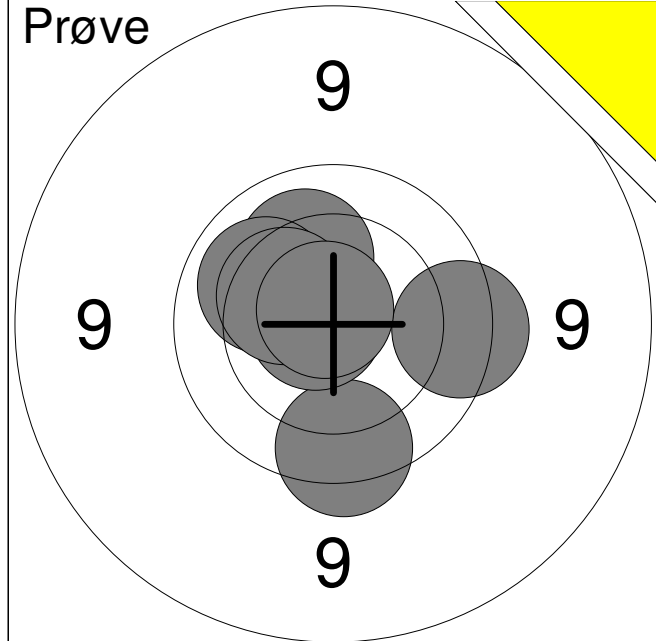

1:	9.7	↓
2:	9.7	→
3:	10.2	↗
4:	10.1	↗
5:	10.8x	←
6:	10.3	↗
7:	10.8x	↗
<b>Serie</b>		<b>68</b>
<b>Total</b>		<b>0</b>

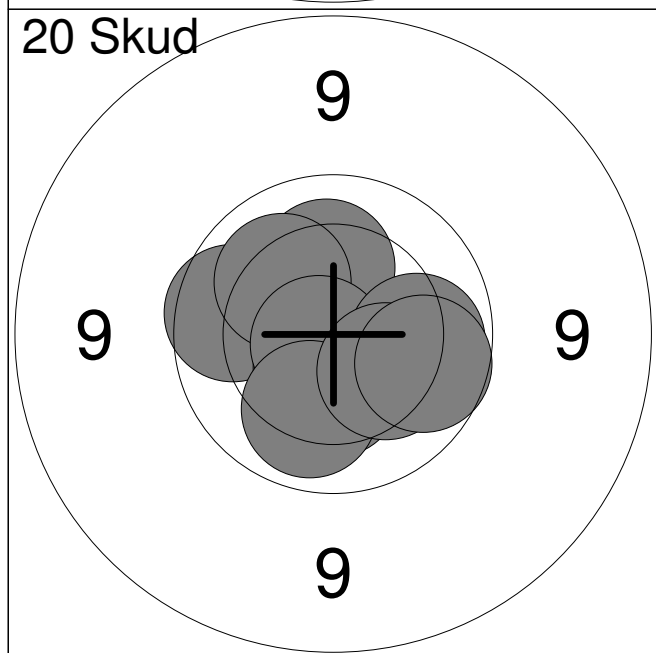

1:	9.9	←
2:	10.2	↑
3:	10.1	↗
4:	10.6x	↓
5:	10.4	↓
6:	10.8x	↖
7:	10.1	↓
8:	10.0	→
9:	10.2	↘
10:	9.9	→
<b>Serie</b>		<b>98</b>
<b>Total</b>		<b>98</b>

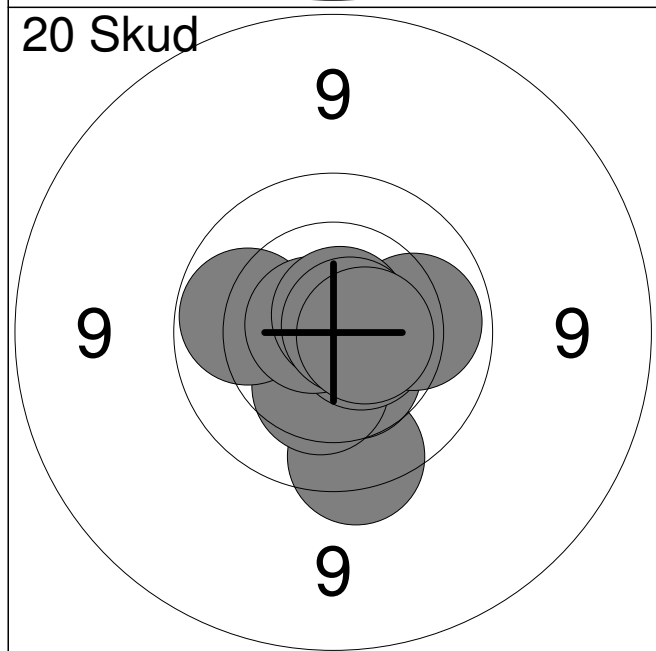

11:	9.7	↓
12:	10.5	↘
13:	10.3	↘
14:	10.0	←
15:	10.6x	↘
16:	10.7x	↖
17:	10.1	→
18:	10.7x	↗
19:	10.8x	↗
20:	10.6x	→
<b>Serie</b>		<b>99</b>
<b>Total</b>		<b>197</b>

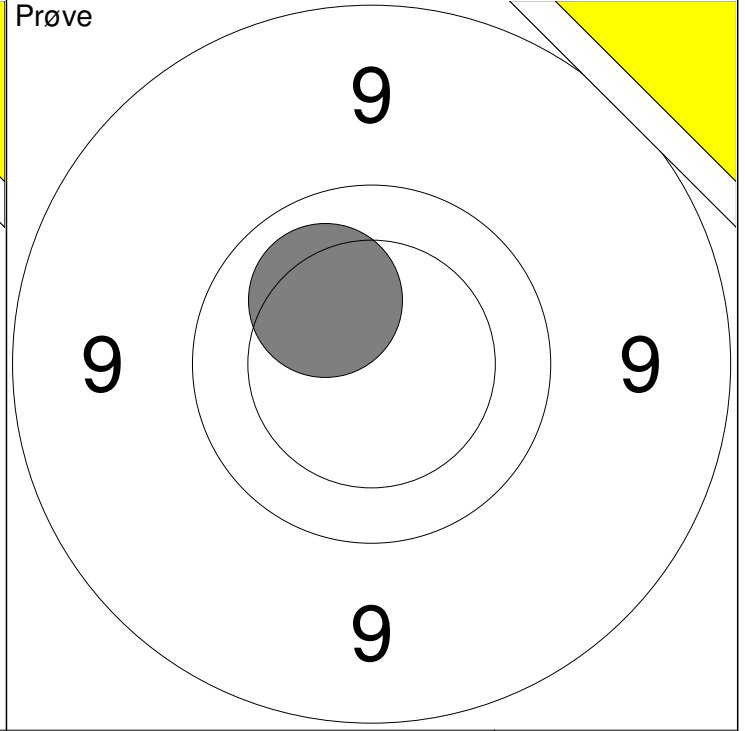
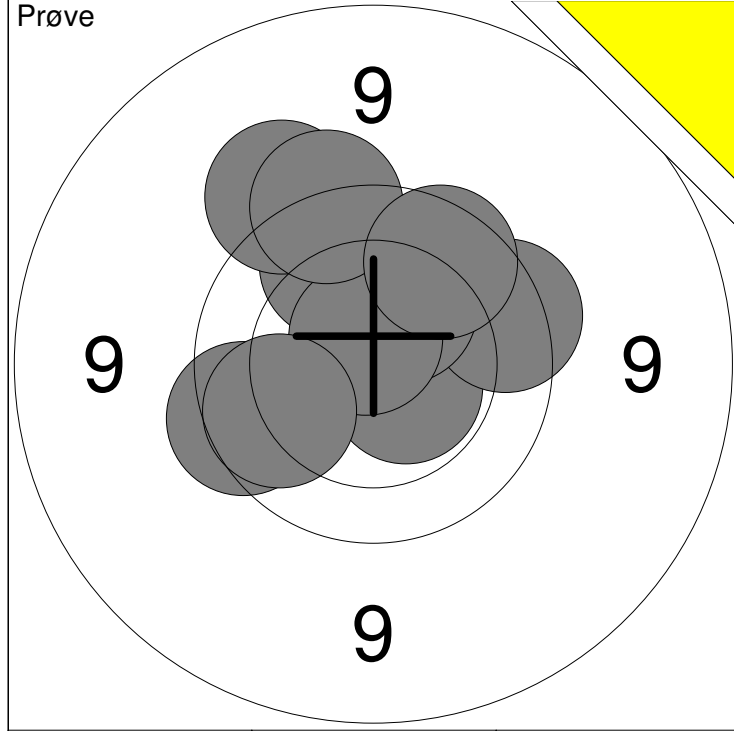

1: 10.6x ↘	6: 9.5 ↖	Serie	93
2: 9.7 →	7: 9.7 ←		
3: 9.9 ↗	8: 9.9 ←	Total	0
4: 10.3 ↗	9: 9.6 ↗		
5: 10.7x ↗	10: 9.8 ↗		

11: 10.2 ↖	Serie	10
Total		0

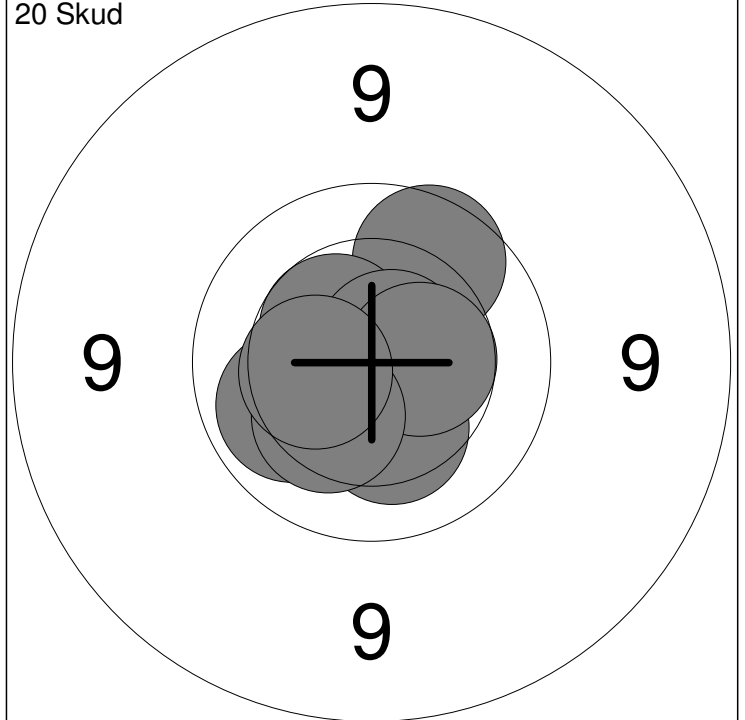
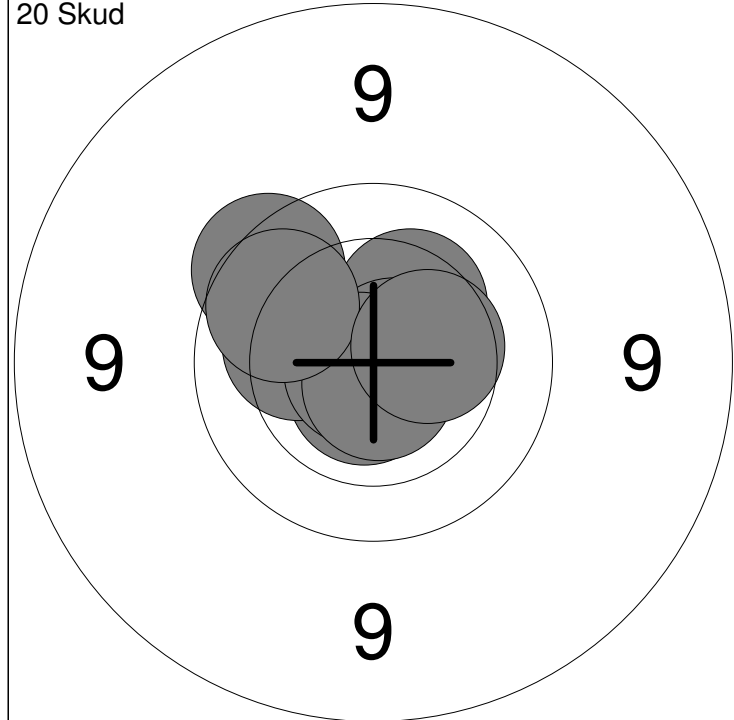

1: 10.6x ↖	6: 10.8x ←	Serie	98
2: 10.3 ↗	7: 10.7x ↓		
3: 10.7x →	8: 9.7 ↖	Total	98
4: 10.7x ↓	9: 9.9 ↖		
5: 10.2 ←	10: 10.4 →		

11: 10.5x ↓	16: 10.3 ↓	Serie	99
12: 9.9 ↗	17: 10.5 →		
13: 10.5 ↓	18: 10.1 ←	Total	197
14: 10.5 ↖	19: 10.3 ↓		
15: 10.7x ↗	20: 10.4 ←		



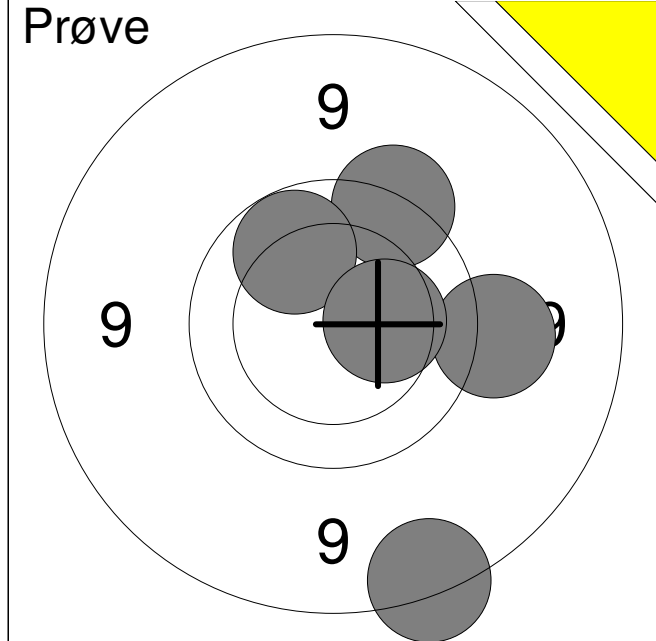

1:	9.4	→
2:	9.6	↗
3:	10.0	↗
4:	8.7	↘
5:	10.3	→

Serie	46
-------	----

Total	0
-------	---

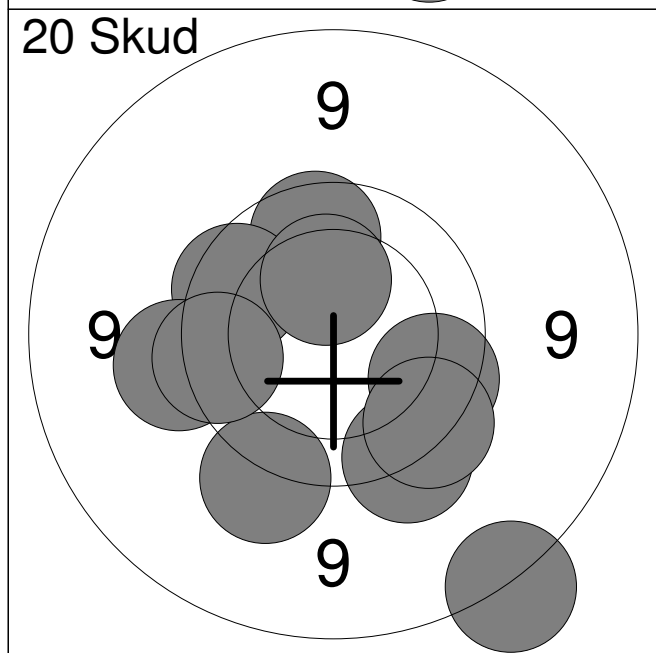

1:	9.9	↑
2:	9.8	↖
3:	9.8	↘
4:	9.5	←
5:	9.5	↘
6:	8.7	↘
7:	10.3	↑
8:	9.7	←
9:	9.6	↘
10:	9.7	↘

Serie	90
-------	----

Total	90
-------	----

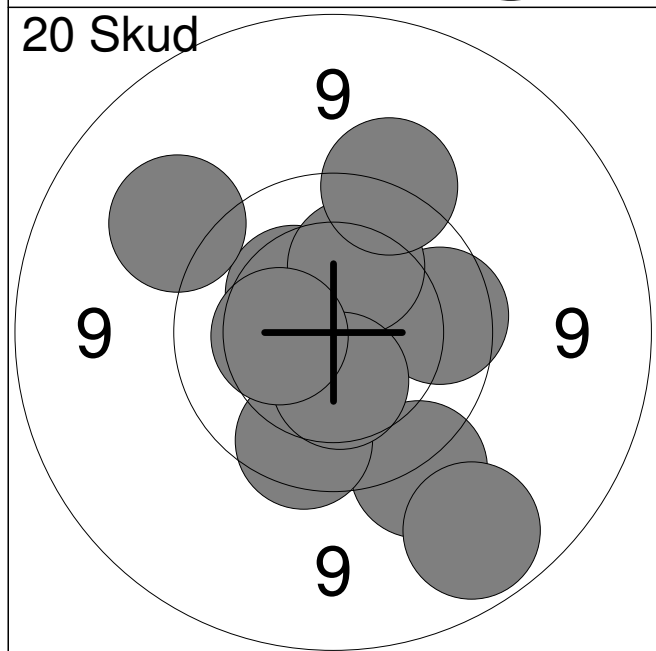

11:	9.5	↘
12:	9.0	↘
13:	9.8	↘
14:	10.3	↗
15:	9.3	↗
16:	9.8	→
17:	10.2	↑
18:	9.5	↑
19:	10.4	↘
20:	10.4	←

Serie	94
-------	----

Total	184
-------	-----

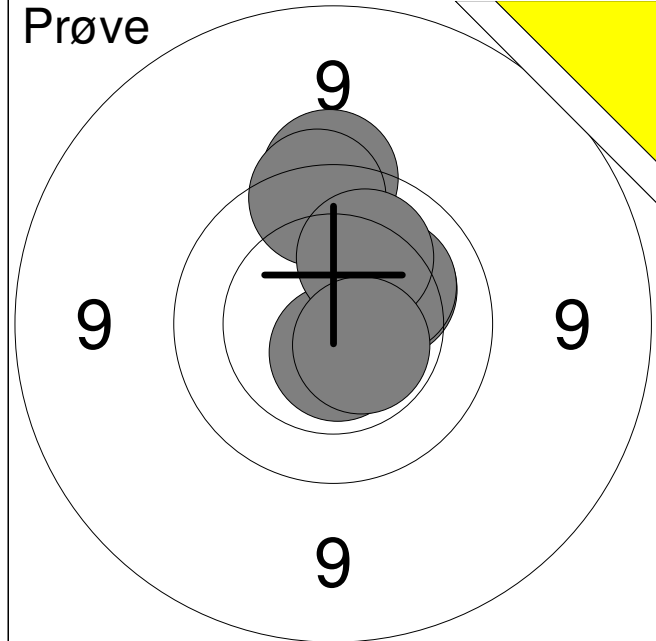

1:	9.6	↑
2:	9.7	↑
3:	10.2	↗
4:	10.2	↗
5:	10.6x	↓
6:	10.1	↗
7:	10.6x	↘
<b>Serie</b>		<b>68</b>
<b>Total</b>		<b>0</b>

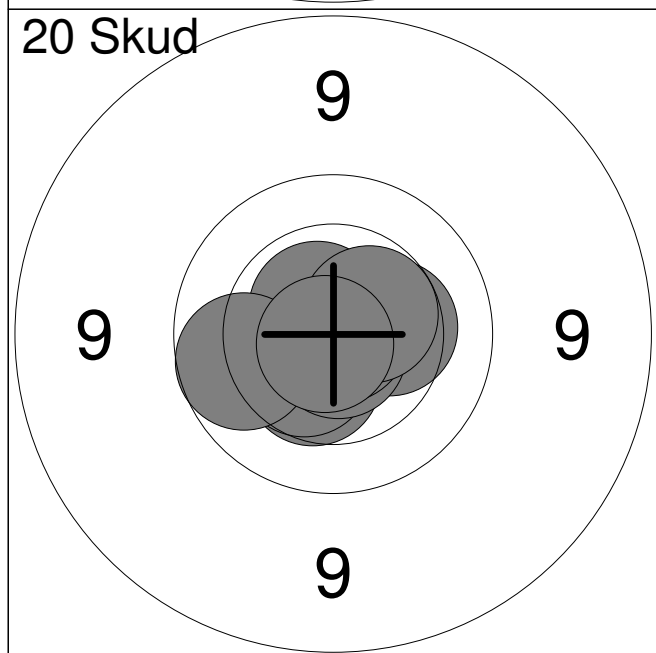

1:	10.3	→
2:	10.4	↓
3:	10.8x	←
4:	10.5	↓
5:	10.8x	↓
6:	10.9x	→
7:	10.6x	↗
8:	10.5x	↗
9:	9.9	←
10:	10.8x	↓
<b>Serie</b>		<b>99</b>
<b>Total</b>		<b>99</b>

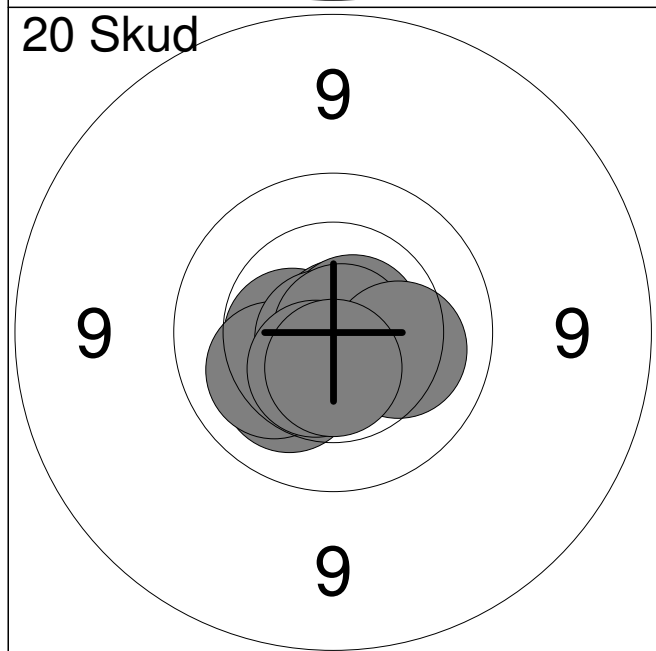

11:	10.2	↓
12:	10.5x	←
13:	10.8x	↗
14:	10.7x	↗
15:	10.2	←
16:	10.8x	←
17:	10.9x	→
18:	10.5x	↓
19:	10.2	→
20:	10.6x	↓
<b>Serie</b>		<b>100</b>
<b>Total</b>		<b>199</b>

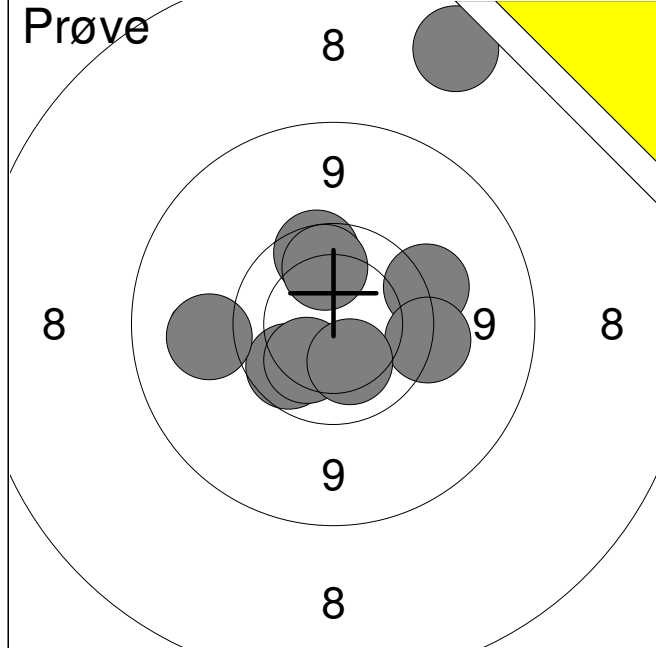

1:	9.5	➔
2:	9.6	➔
3:	9.9	↙
4:	8.0	↗
5:	9.8	↗
6:	9.9	↗
7:	10.2	↙
8:	10.2	↙
9:	9.3	←

Serie	82
-------	----

Total	0
-------	---

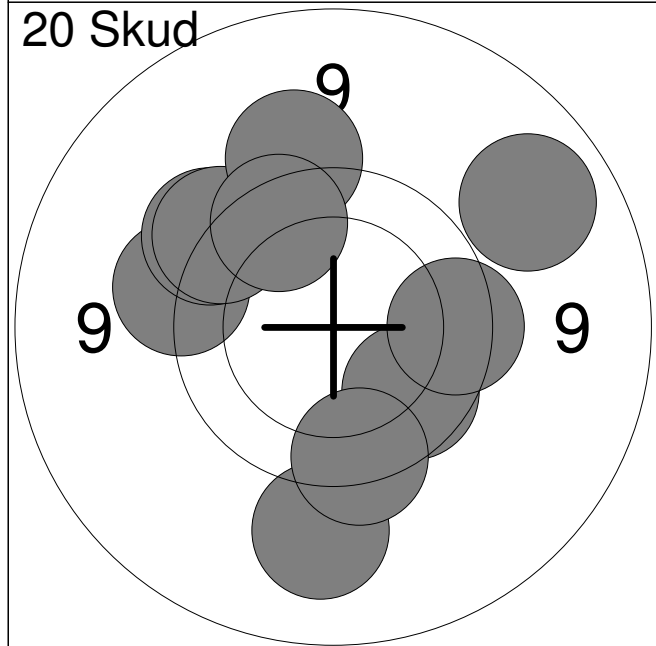

1:	9.9	↘
2:	9.2	↓
3:	9.1	➔
4:	9.7	↓
5:	9.5	←
6:	9.6	↗
7:	9.6	↗
8:	9.7	➔
9:	9.4	↗
10:	9.8	↗

Serie	90
-------	----

Total	90
-------	----

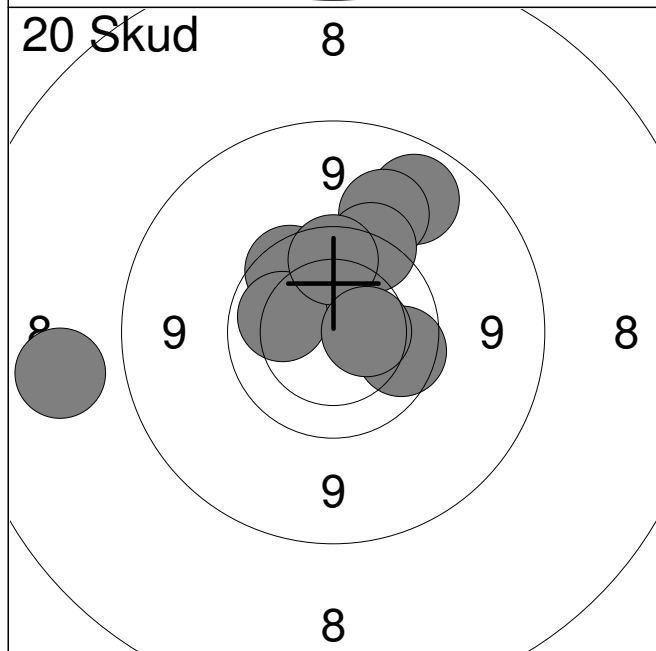

11:	9.9	↗
12:	8.3	←
13:	9.8	↗
14:	9.1	↗
15:	10.1	←
16:	9.9	➔
17:	9.3	↗
18:	9.6	↗
19:	9.8	↗
20:	10.4	➔

Serie	91
-------	----

Total	181
-------	-----

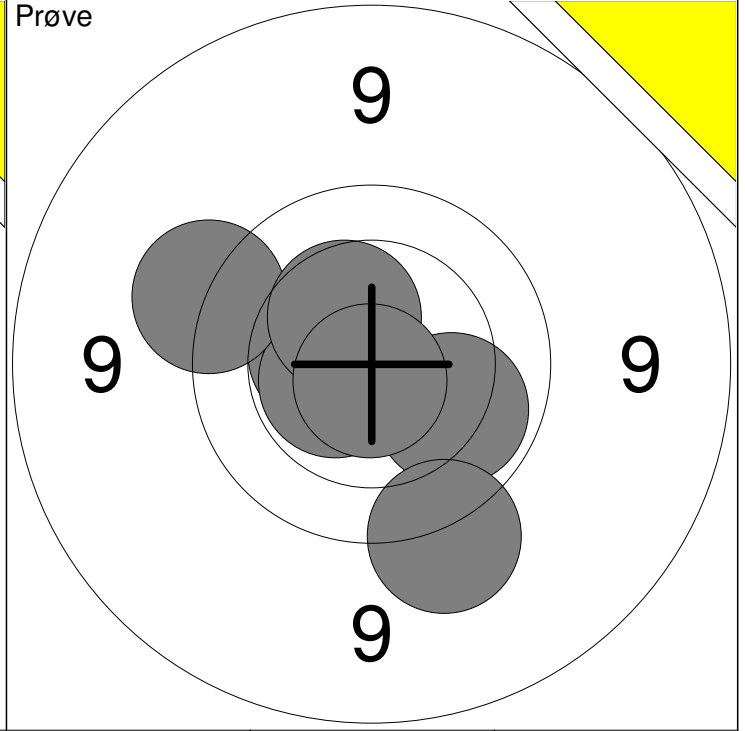
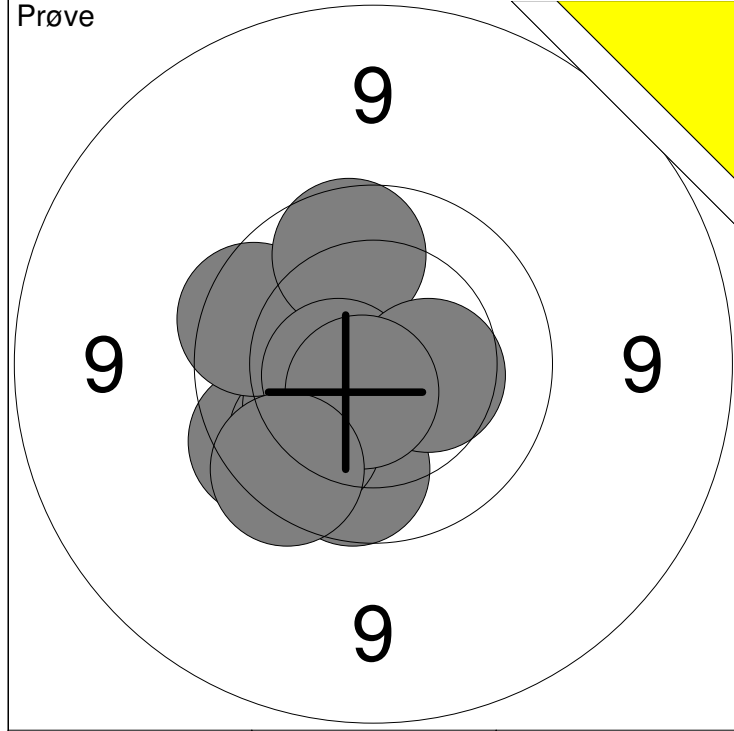

1: 9.8 ↙	6: 9.9 ↑	Serie	95
2: 9.9 ↓	7: 10.6x ←		
3: 10.0 ↙	8: 10.4 →	Total	0
4: 10.3 ↙	9: 10.7x ↓		
5: 9.8 ←	10: 9.8 ↙		

11: 10.5 ←	16: 10.4 ↗	Serie	68
12: 10.6x ←	17: 10.8x ↓		
13: 10.1 ↘		Total	0
14: 9.5 ←			
15: 9.5 ↓			

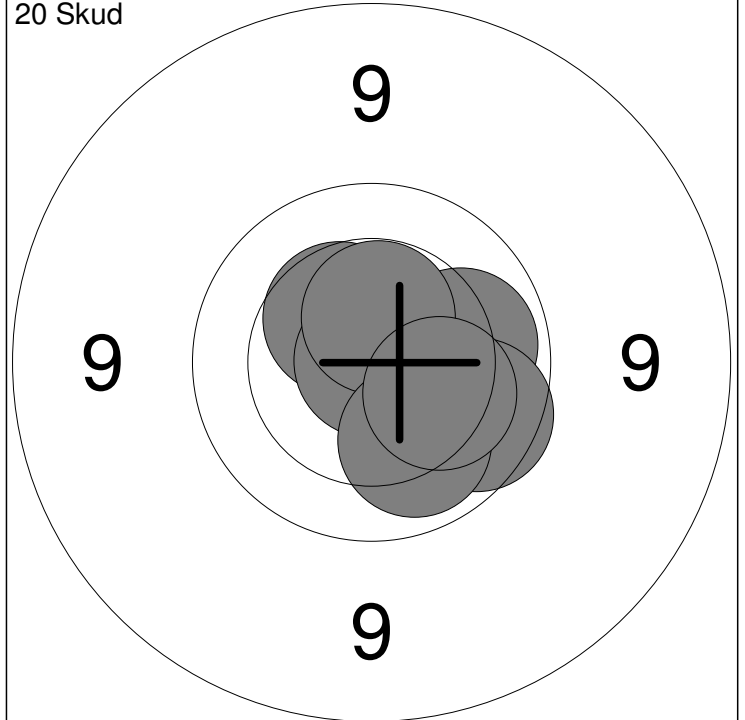
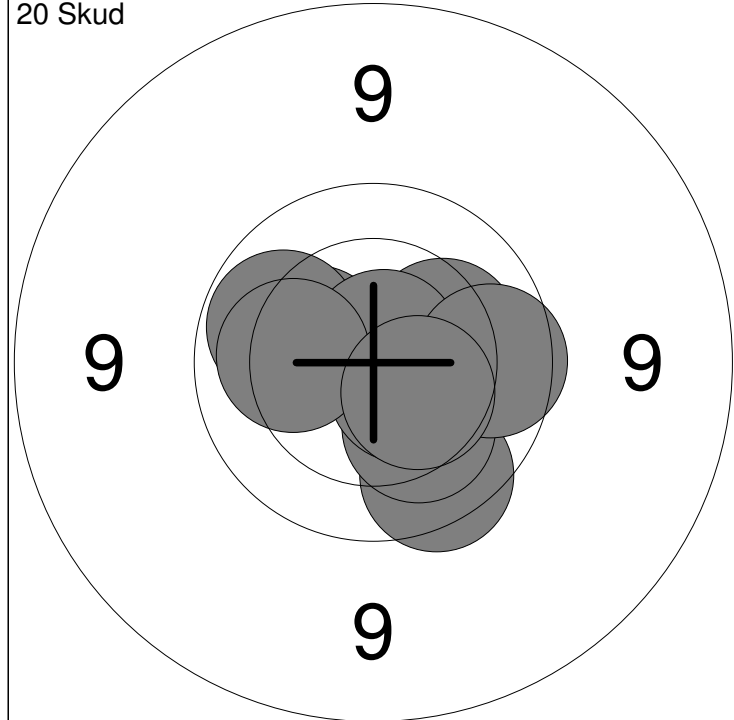

1: 10.2 →	6: 10.6x ↘	Serie	98
2: 9.8 ↓	7: 10.8x ↗		
3: 10.2 ↘	8: 10.2 ←	Total	98
4: 10.3 ←	9: 9.9 →		
5: 10.0 ←	10: 10.4 ↘		

11: 10.6x ↑	16: 10.4 ↗	Serie	99
12: 10.9x ↑	17: 10.9x ↗		
13: 10.1 →	18: 10.5x ↑	Total	197
14: 10.8x →	19: 10.1 ↓		
15: 9.9 ↘	20: 10.2 ↘		

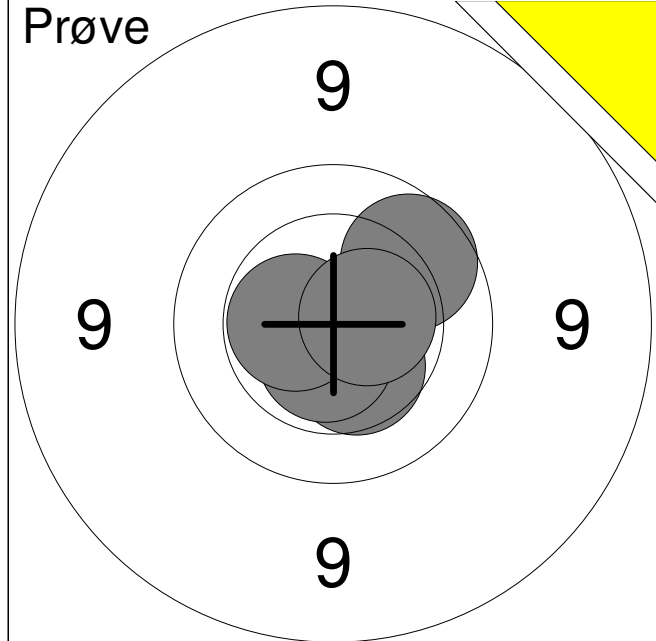

1:	9.9	↗
2:	10.4	↘
3:	10.6x	↘
4:	10.5x	←
5:	10.6x	→
<b>Serie</b>		<b>49</b>
<b>Total</b>		<b>0</b>

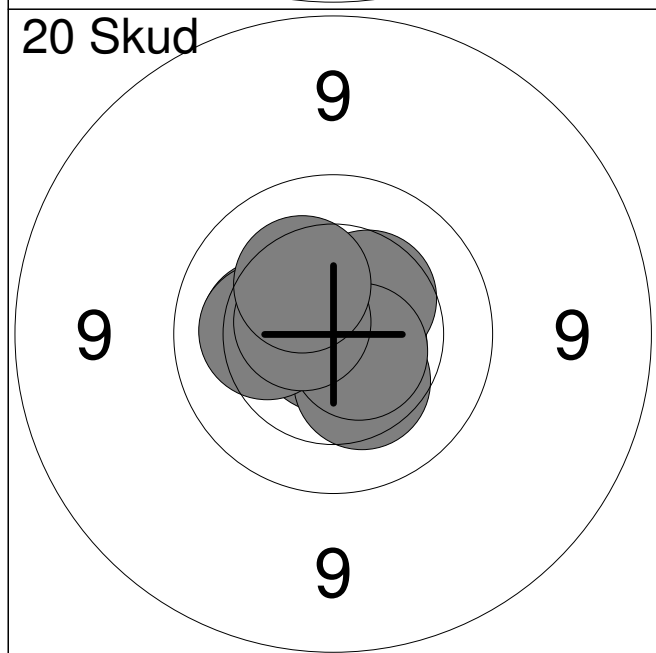

1:	10.6x	↘
2:	10.7x	→
3:	10.8x	↘
4:	10.3	↘
5:	10.4	↗
6:	10.2	←
7:	10.6x	↘
8:	10.2	←
9:	10.6x	↖
10:	10.3	↗
<b>Serie</b>		<b>100</b>
<b>Total</b>		<b>100</b>

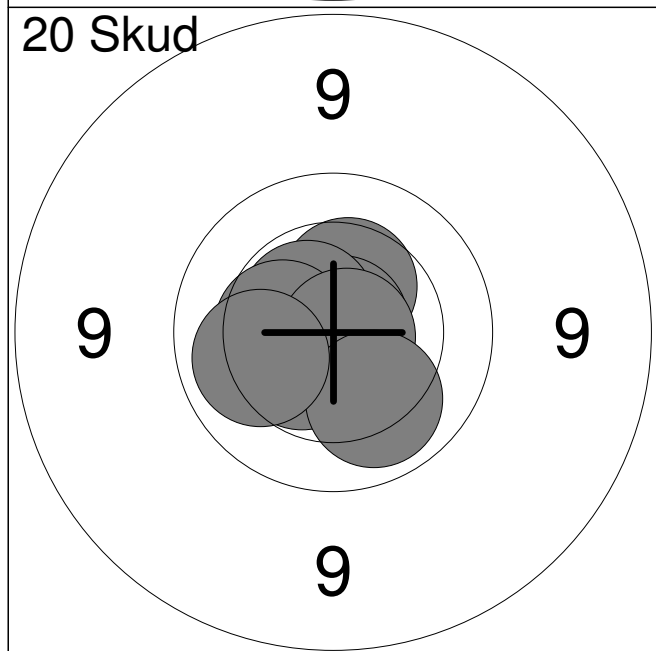

11:	10.5	←
12:	10.5	↘
13:	10.4	↗
14:	10.8x	←
15:	10.8x	↗
16:	10.6x	↗
17:	10.4	←
18:	10.8x	→
19:	10.1	↘
20:	10.1	←
<b>Serie</b>		<b>100</b>
<b>Total</b>		<b>200</b>

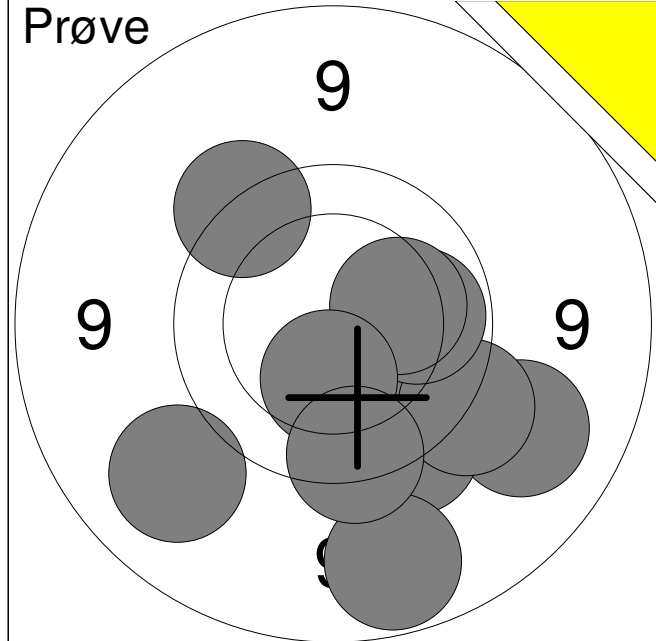

1:	9.2	↘
2:	9.6	↗
3:	9.6	↘
4:	9.5	↘
5:	9.0	↘
6:	10.0	→
7:	10.2	→
8:	10.3	↘
9:	9.7	↘
10:	9.2	↙
<b>Serie</b>		<b>93</b>
<b>Total</b>		<b>0</b>

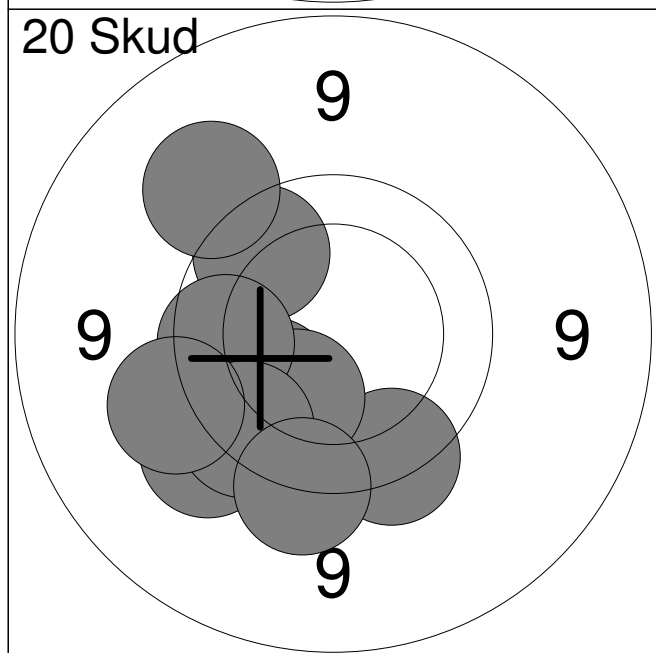

1:	9.7	↘
2:	9.5	↙
3:	10.0	↙
4:	10.1	↘
5:	9.8	↗
6:	9.3	↗
7:	9.8	←
8:	9.7	↙
9:	9.4	←
10:	9.5	↘
<b>Serie</b>		<b>92</b>
<b>Total</b>		<b>92</b>

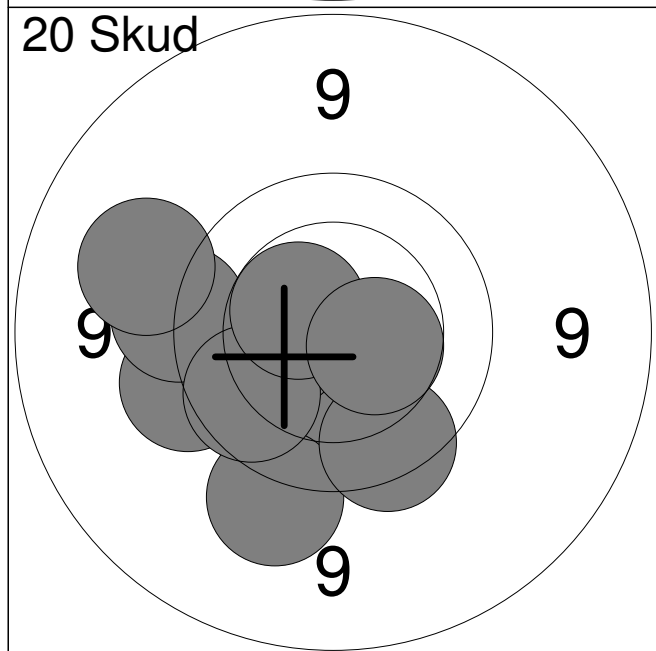

11:	9.6	←
12:	9.9	↘
13:	10.3	←
14:	9.5	←
15:	9.4	↘
16:	9.3	←
17:	9.9	↙
18:	10.5x	↗
19:	9.7	↘
20:	10.5	→
<b>Serie</b>		<b>93</b>
<b>Total</b>		<b>185</b>

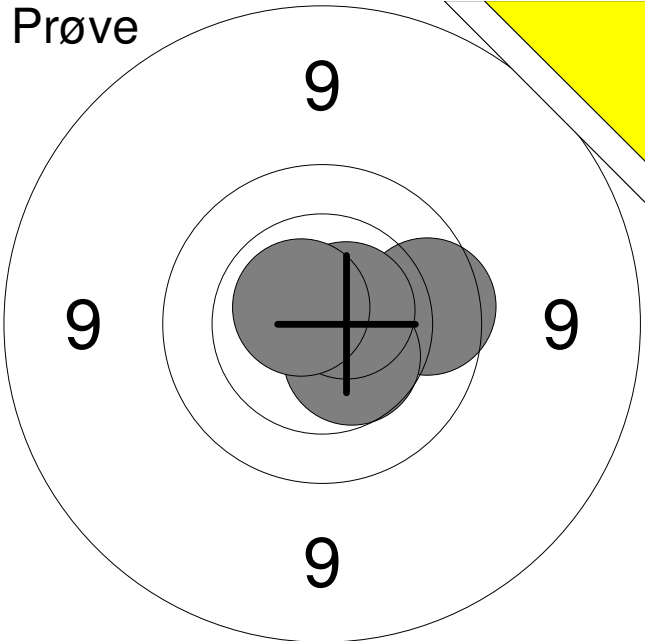
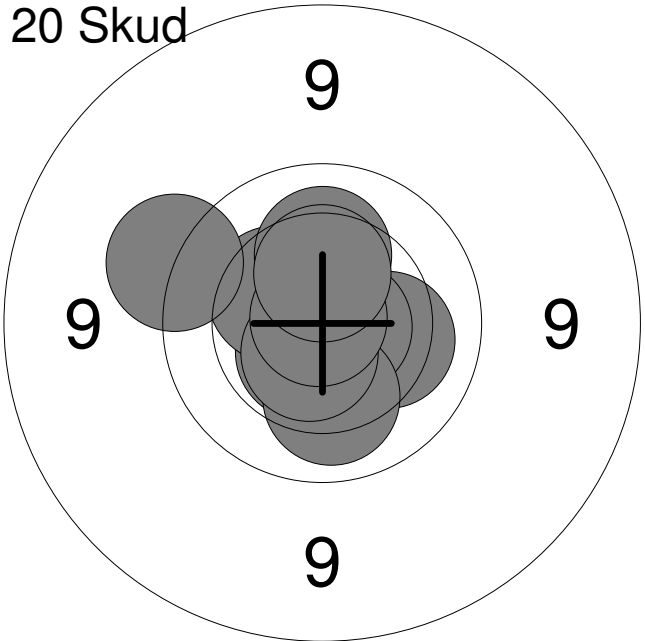
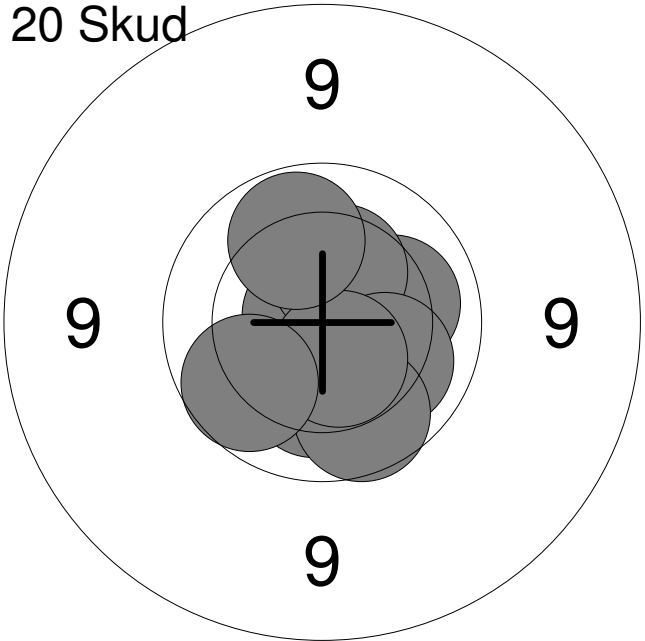
Hold <b>51</b>	Skive <b>9</b>	<b>Evan Pedersen</b>		
Aalborg		Vilsted Skytteforening		MVÅ1
		Nordjysk mesterskab 2018	Aalborg Skyttekreds	
<b>Prøve</b> 		1: 10.8x	↗	
		2: 9.8	→	
		3: 10.5	↘	
		4: 10.6x	↗	
		5: 10.7x	↗	
		<b>Serie</b>	<b>49</b>	
		<b>Total</b>	<b>0</b>	
<b>20 Skud</b> 		1: 10.2	→	
		2: 10.6x	↘	
		3: 10.7x	→	
		4: 10.3	↗	
		5: 10.1	↘	
		6: 10.2	↑	
		7: 10.6x	↘	
		8: 10.9x	↗	
		9: 9.5	↖	
		10: 10.4	↑	
		<b>Serie</b>	<b>99</b>	
		<b>Total</b>	<b>99</b>	
<b>20 Skud</b> 		11: 10.2	↘	
		12: 10.1	→	
		13: 10.8x	↗	
		14: 10.4	↗	
		15: 10.4	↘	
		16: 10.1	↘	
		17: 9.9	↘	
		18: 10.5x	↘	
		19: 9.9	↖	
		20: 10.0	↗	
		<b>Serie</b>	<b>98</b>	
		<b>Total</b>	<b>197</b>	

Hold <b>51</b>	Skive <b>10</b>	<b>Arne Jacobsen</b>																																						
Aalborg		Mou og Omegns Skytteforening		MFRI																																				
		Nordjysk mesterskab 2018	Aalborg Skyttekreds																																					
<b>Prøve</b>		<table border="0"> <tr><td>1:</td><td>9.1</td><td>←</td></tr> <tr><td>2:</td><td>10.0</td><td>↓</td></tr> <tr><td>3:</td><td>8.5</td><td>↓</td></tr> <tr><td>4:</td><td>8.9</td><td>↓</td></tr> <tr><td>5:</td><td>8.9</td><td>↓</td></tr> <tr><td>6:</td><td>9.1</td><td>↓</td></tr> <tr><td>7:</td><td>9.3</td><td>↓</td></tr> <tr><td>8:</td><td>9.2</td><td>↓</td></tr> <tr><td>9:</td><td>9.1</td><td>↓</td></tr> <tr><td>10:</td><td>10.0</td><td>↓</td></tr> <tr><td colspan="2"><b>Serie</b></td><td><b>89</b></td></tr> <tr><td colspan="2"><b>Total</b></td><td><b>0</b></td></tr> </table>			1:	9.1	←	2:	10.0	↓	3:	8.5	↓	4:	8.9	↓	5:	8.9	↓	6:	9.1	↓	7:	9.3	↓	8:	9.2	↓	9:	9.1	↓	10:	10.0	↓	<b>Serie</b>		<b>89</b>	<b>Total</b>		<b>0</b>
1:	9.1	←																																						
2:	10.0	↓																																						
3:	8.5	↓																																						
4:	8.9	↓																																						
5:	8.9	↓																																						
6:	9.1	↓																																						
7:	9.3	↓																																						
8:	9.2	↓																																						
9:	9.1	↓																																						
10:	10.0	↓																																						
<b>Serie</b>		<b>89</b>																																						
<b>Total</b>		<b>0</b>																																						
<b>20 Skud</b>		<table border="0"> <tr><td>1:</td><td>9.9</td><td>↗</td></tr> <tr><td>2:</td><td>9.4</td><td>↓</td></tr> <tr><td>3:</td><td>8.6</td><td>↙</td></tr> <tr><td>4:</td><td>9.3</td><td>↓</td></tr> <tr><td>5:</td><td>8.9</td><td>→</td></tr> <tr><td>6:</td><td>9.8</td><td>↙</td></tr> <tr><td>7:</td><td>9.7</td><td>↑</td></tr> <tr><td>8:</td><td>9.4</td><td>↓</td></tr> <tr><td>9:</td><td>9.2</td><td>↓</td></tr> <tr><td>10:</td><td>8.8</td><td>↓</td></tr> <tr><td colspan="2"><b>Serie</b></td><td><b>87</b></td></tr> <tr><td colspan="2"><b>Total</b></td><td><b>87</b></td></tr> </table>			1:	9.9	↗	2:	9.4	↓	3:	8.6	↙	4:	9.3	↓	5:	8.9	→	6:	9.8	↙	7:	9.7	↑	8:	9.4	↓	9:	9.2	↓	10:	8.8	↓	<b>Serie</b>		<b>87</b>	<b>Total</b>		<b>87</b>
1:	9.9	↗																																						
2:	9.4	↓																																						
3:	8.6	↙																																						
4:	9.3	↓																																						
5:	8.9	→																																						
6:	9.8	↙																																						
7:	9.7	↑																																						
8:	9.4	↓																																						
9:	9.2	↓																																						
10:	8.8	↓																																						
<b>Serie</b>		<b>87</b>																																						
<b>Total</b>		<b>87</b>																																						
<b>20 Skud</b>		<table border="0"> <tr><td>11:</td><td>9.2</td><td>↓</td></tr> <tr><td>12:</td><td>8.6</td><td>↓</td></tr> <tr><td>13:</td><td>9.3</td><td>↙</td></tr> <tr><td>14:</td><td>9.3</td><td>↙</td></tr> <tr><td>15:</td><td>9.2</td><td>↓</td></tr> <tr><td>16:</td><td>9.8</td><td>↙</td></tr> <tr><td>17:</td><td>9.5</td><td>↙</td></tr> <tr><td>18:</td><td>10.2</td><td>↙</td></tr> <tr><td>19:</td><td>10.2</td><td>↙</td></tr> <tr><td>20:</td><td>9.5</td><td>↓</td></tr> <tr><td colspan="2"><b>Serie</b></td><td><b>91</b></td></tr> <tr><td colspan="2"><b>Total</b></td><td><b>178</b></td></tr> </table>			11:	9.2	↓	12:	8.6	↓	13:	9.3	↙	14:	9.3	↙	15:	9.2	↓	16:	9.8	↙	17:	9.5	↙	18:	10.2	↙	19:	10.2	↙	20:	9.5	↓	<b>Serie</b>		<b>91</b>	<b>Total</b>		<b>178</b>
11:	9.2	↓																																						
12:	8.6	↓																																						
13:	9.3	↙																																						
14:	9.3	↙																																						
15:	9.2	↓																																						
16:	9.8	↙																																						
17:	9.5	↙																																						
18:	10.2	↙																																						
19:	10.2	↙																																						
20:	9.5	↓																																						
<b>Serie</b>		<b>91</b>																																						
<b>Total</b>		<b>178</b>																																						



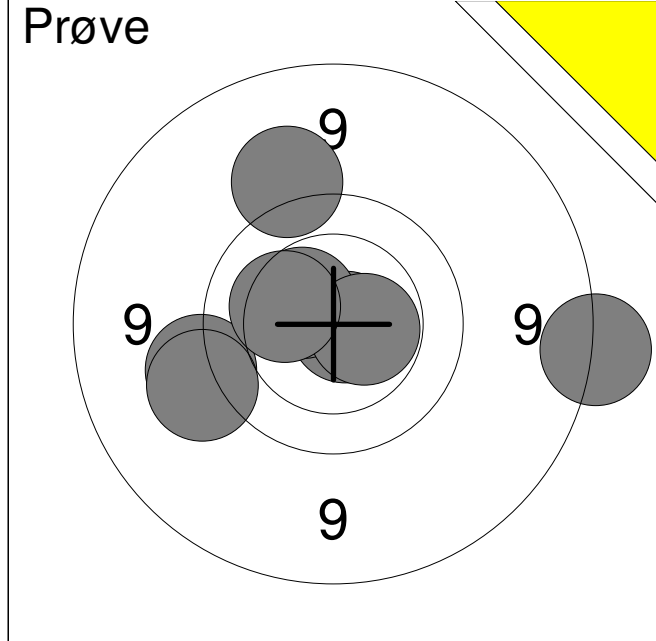

1:	8.7	→
2:	9.4	←
3:	10.8x	→
4:	9.4	←
5:	10.4	↗
6:	9.4	↗
7:	10.5x	→
8:	10.3	←
<b>Serie</b>		<b>75</b>
<b>Total</b>		<b>0</b>

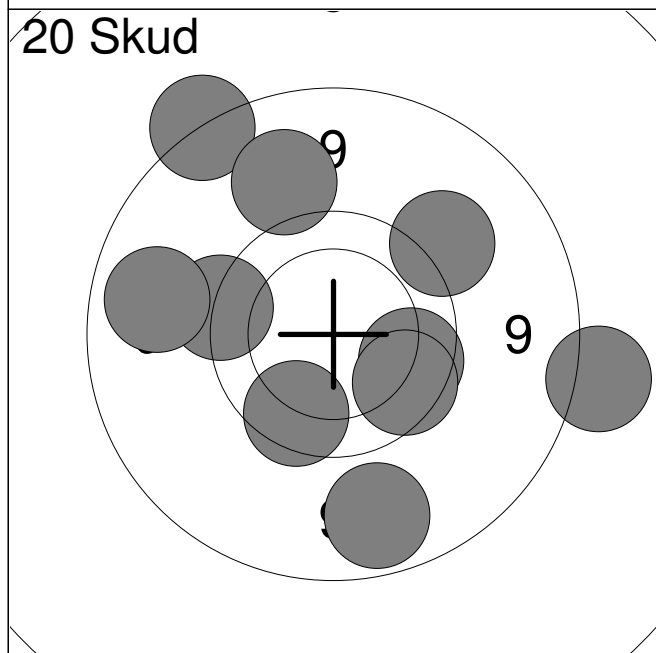

1:	8.7	↗
2:	9.0	↓
3:	8.6	→
4:	9.8	↓
5:	9.6	←
6:	9.4	↗
7:	9.1	←
8:	9.8	→
9:	9.2	↗
10:	9.8	↓
<b>Serie</b>		<b>88</b>
<b>Total</b>		<b>88</b>

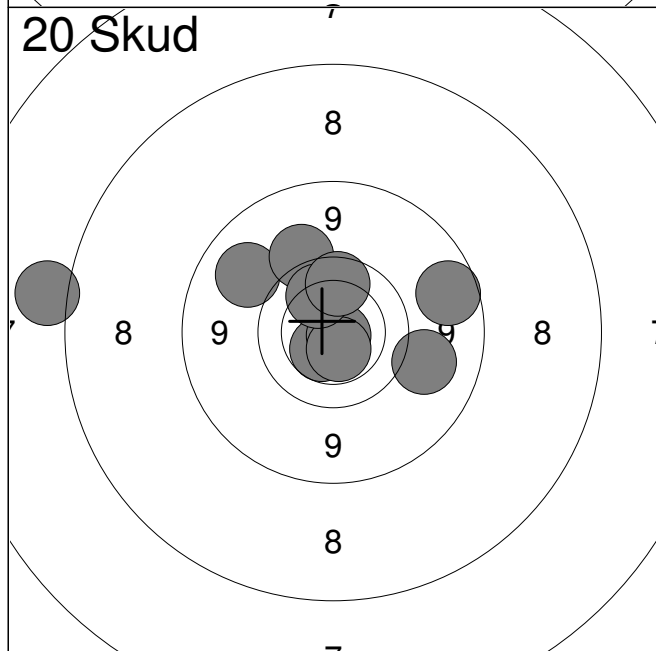

11:	9.2	↗
12:	9.3	→
13:	7.5	←
14:	10.5	↓
15:	10.8x	↘
16:	9.4	↗
17:	10.5x	↓
18:	8.9	→
19:	10.0	↗
20:	9.9	↑
<b>Serie</b>		<b>91</b>
<b>Total</b>		<b>179</b>

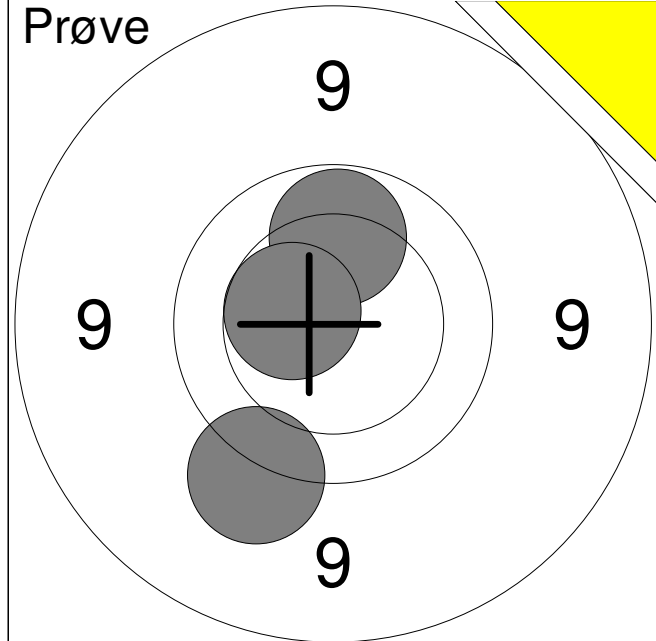

1:	9.5	↘
2:	10.0	↑
3:	10.5	←
<b>Serie</b>		<b>29</b>
<b>Total</b>		<b>0</b>

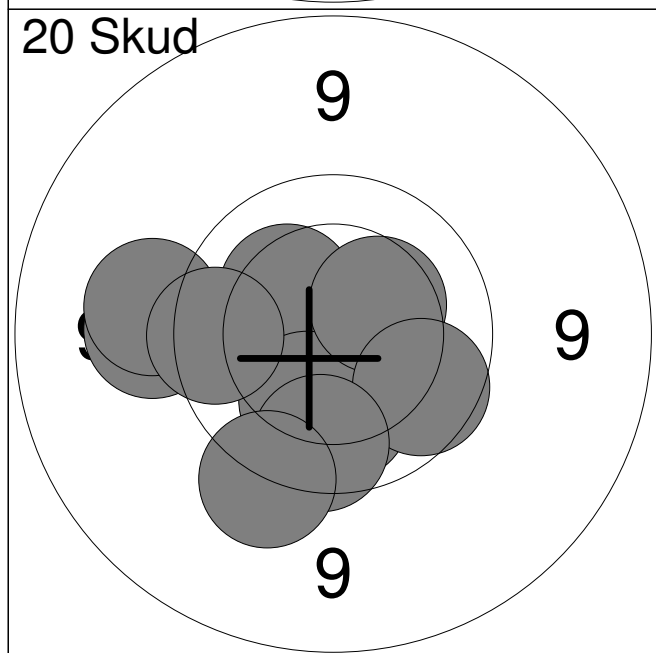

1:	10.1	↓
2:	10.3	↗
3:	10.2	↓
4:	9.4	←
5:	9.4	←
6:	10.4	↗
7:	9.9	↘
8:	9.8	↓
9:	9.8	←
10:	9.5	↓
<b>Serie</b>		<b>94</b>
<b>Total</b>		<b>94</b>

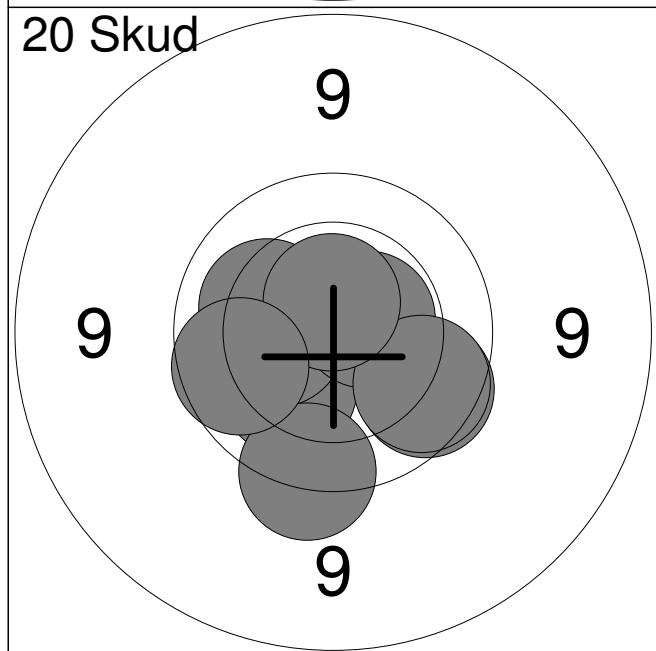

11:	10.2	↘
12:	10.7x	↑
13:	10.3	←
14:	10.6x	↗
15:	9.6	↓
16:	9.8	↘
17:	9.9	↘
18:	10.2	↖
19:	10.6x	↑
20:	9.9	←
<b>Serie</b>		<b>96</b>
<b>Total</b>		<b>190</b>

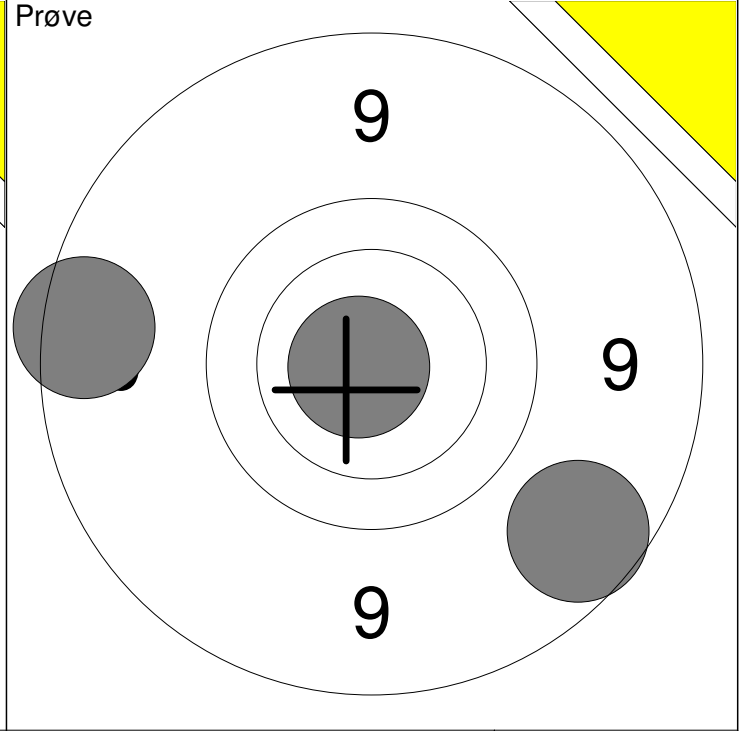
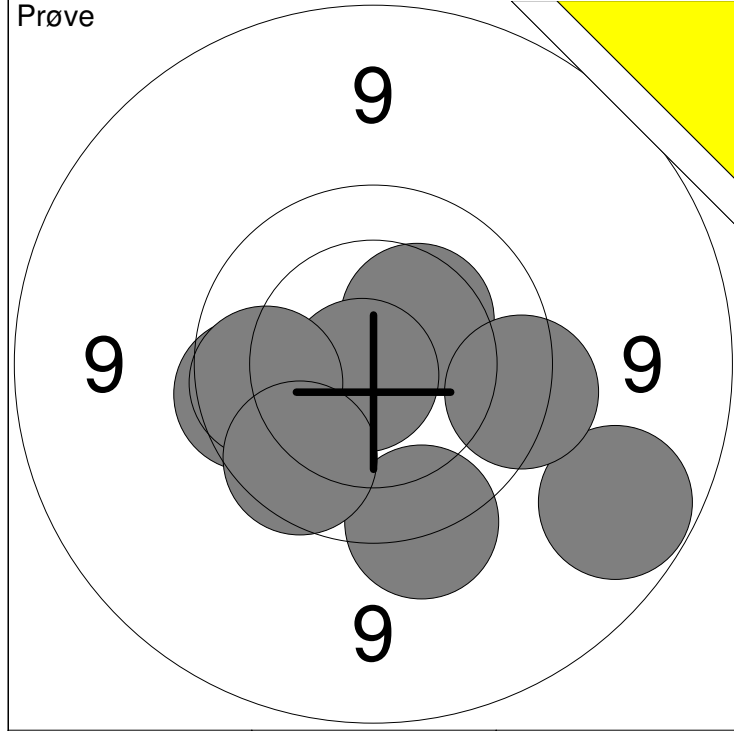

1: 10.3 ↗	7: 9.8 ←	Serie	74
2: 9.6 ↓	8: 9.9 ←		
3: 9.0 ↘	10: 9.9 ↙	Total	0
5: 9.7 →			
6: 10.8x ↙			

11: 8.8 ←	Serie	26
12: 8.9 ↘		
13: 10.8x ←	Total	0

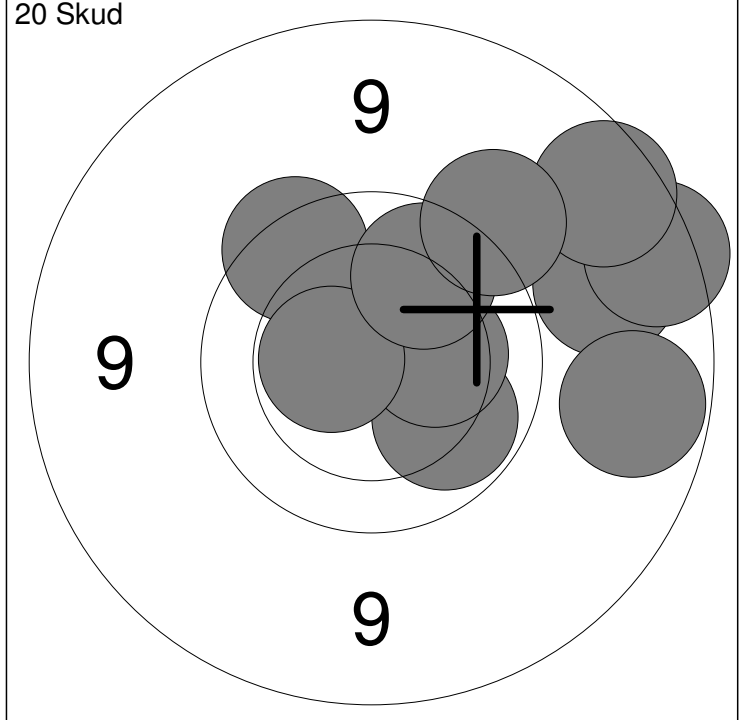
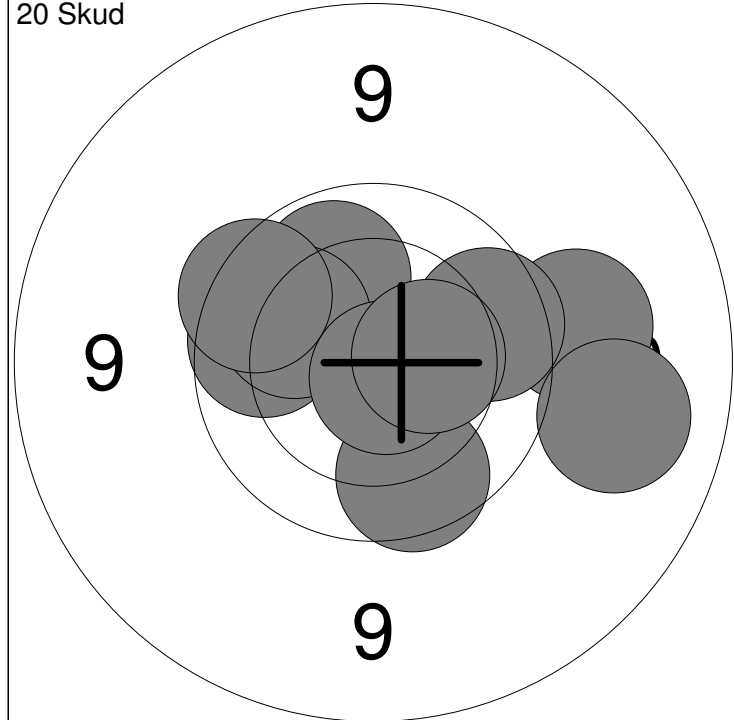

1: 10.0 ↗	6: 10.1 ↙	Serie	94
2: 9.4 →	7: 10.8x ↘		
3: 9.8 →	8: 10.4 →	Total	94
4: 9.9 ←	9: 9.1 →		
5: 9.9 ↓	10: 9.8 ↙		

11: 9.7 ↗	16: 10.5x ←	Serie	91
12: 10.0 ↘	17: 9.9 ↗		
13: 10.3 →	18: 8.9 ↗	Total	185
14: 9.1 →	19: 9.4 ↗		
15: 8.8 →	20: 9.0 →		

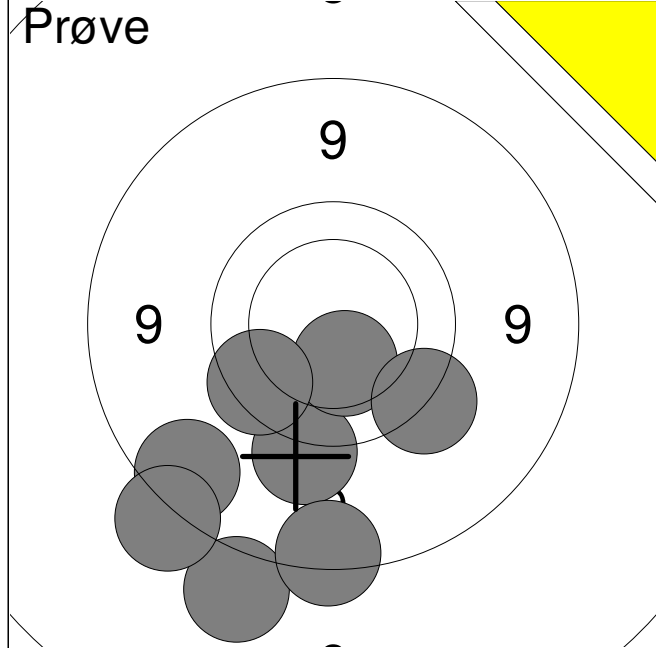

1:	9.5	↓
2:	8.9	↙
3:	8.5	↓
4:	8.6	↙
5:	10.4	↓
6:	9.5	↘
7:	8.8	↓
8:	9.8	↙
<b>Serie</b>		<b>69</b>
<b>Total</b>		<b>0</b>

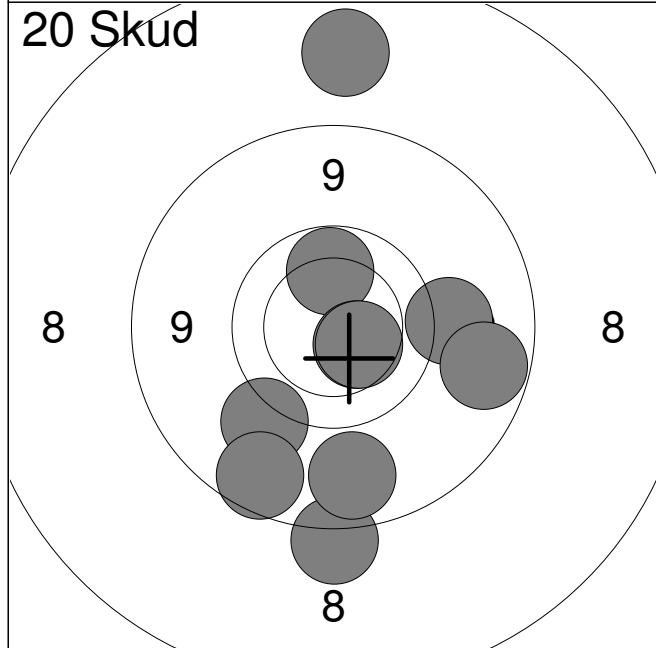

1:	10.0	↑
2:	9.4	↘
3:	9.4	→
4:	8.9	↘
5:	9.0	→
6:	8.6	↓
7:	9.0	↓
8:	10.4	↘
9:	10.4	↘
10:	8.2	↑
<b>Serie</b>		<b>90</b>
<b>Total</b>		<b>90</b>

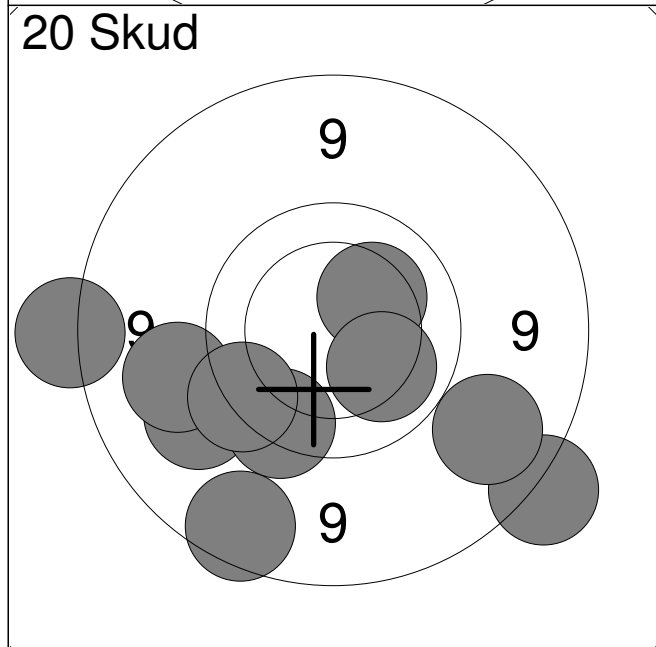

11:	9.3	↙
12:	8.9	↓
13:	8.6	←
14:	8.6	↘
15:	9.7	↘
16:	10.3	↗
17:	9.1	↘
18:	9.2	←
19:	9.6	↙
20:	10.1	↘
<b>Serie</b>		<b>89</b>
<b>Total</b>		<b>179</b>

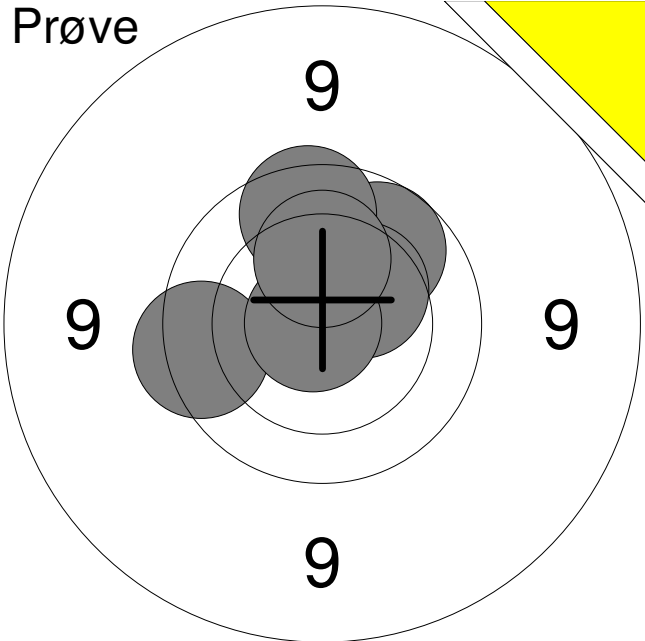
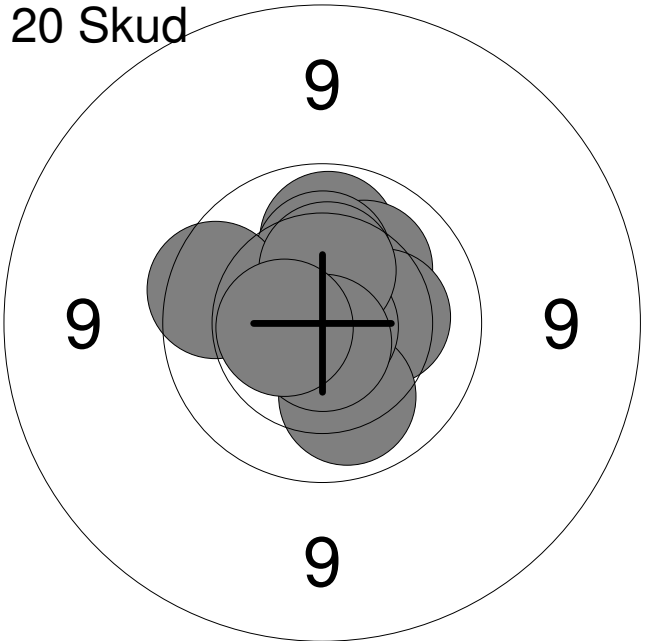
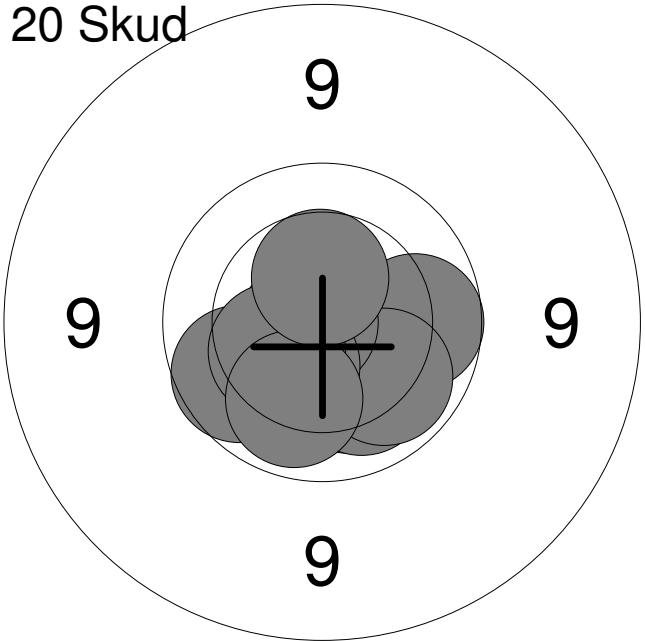
Hold <b>52</b>	Skive <b>4</b>	<b>Rasmus Møller Larsen</b>		
Aalborg		Vilsted Skytteforening		VÅ1
		Nordjysk mesterskab 2018	Aalborg Skyttekreds	
Prøve		1:	10.2	↗
		2:	9.9	↗
		3:	10.4	↗
		4:	9.7	←
		5:	9.8	↑
		6:	10.9x	←
		7:	10.2	↑
		Serie	67	
		Total	0	
20 Skud		1:	10.0	↑
		2:	10.2	↗
		3:	10.3	→
		4:	10.3	↑
		5:	10.1	↓
		6:	10.9x	↘
		7:	9.8	←
		8:	10.4	↑
		9:	10.7x	↓
		10:	10.5x	←
		Serie	99	
		Total	99	
20 Skud		11:	10.2	↓
		12:	9.9	→
		13:	10.1	↓
		14:	10.0	↓
		15:	10.8x	←
		16:	9.9	↙
		17:	10.4	↘
		18:	10.4	←
		19:	10.1	↓
		20:	10.5	↑
		Serie	98	
		Total	197	

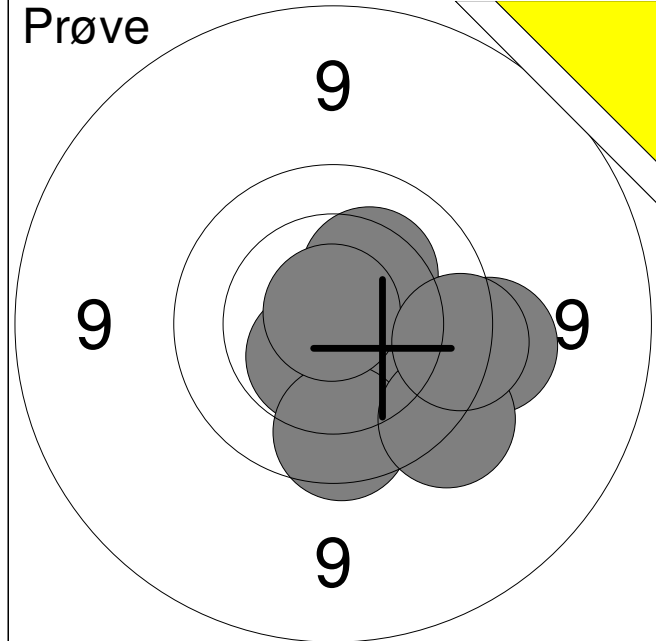

1:	9.8	→
2:	10.5x	↓
3:	9.5	→
4:	10.1	↓
5:	10.3	↗
6:	10.0	↓
7:	9.8	↓
8:	9.6	↘
9:	10.8x	↑
10:	9.7	→
<b>Serie</b>		<b>95</b>
<b>Total</b>		<b>0</b>

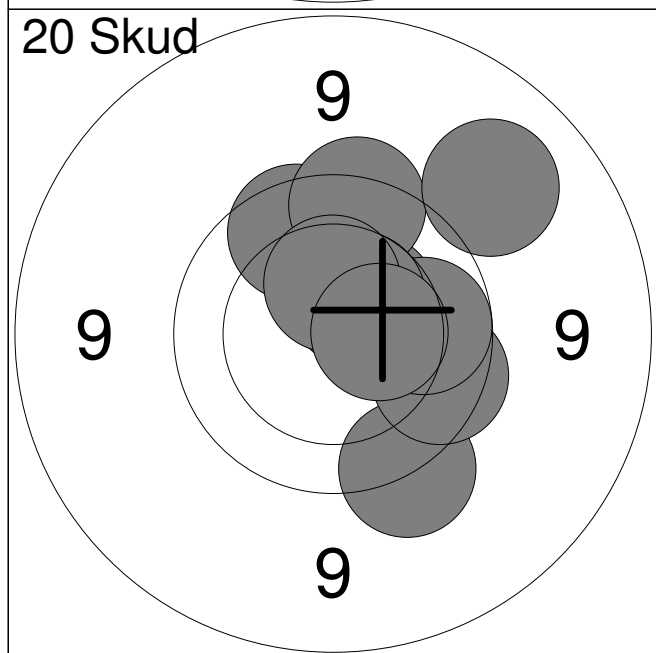

1:	9.8	↑
2:	9.6	↓
3:	9.8	→
4:	10.4	↗
5:	9.7	↑
6:	10.0	→
7:	10.5	↗
8:	10.4	↑
9:	10.4	→
10:	9.2	↘
<b>Serie</b>		<b>95</b>
<b>Total</b>		<b>95</b>

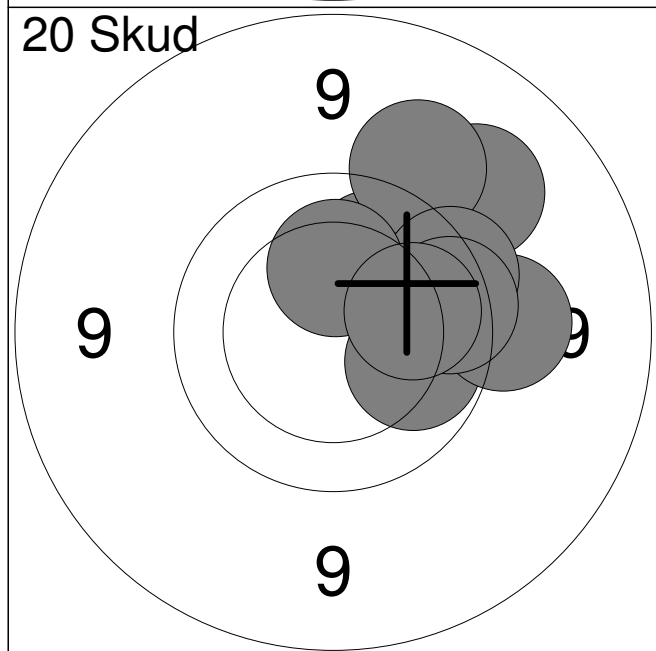

11:	9.3	↗
12:	10.0	→
13:	10.0	↗
14:	9.4	→
15:	9.4	↗
16:	9.9	→
17:	9.7	↗
18:	10.2	↑
19:	9.8	→
20:	10.0	→
<b>Serie</b>		<b>94</b>
<b>Total</b>		<b>189</b>

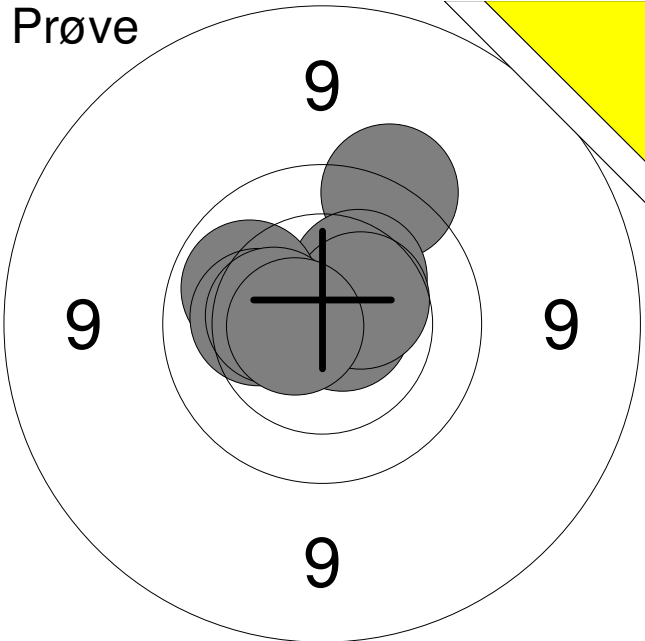
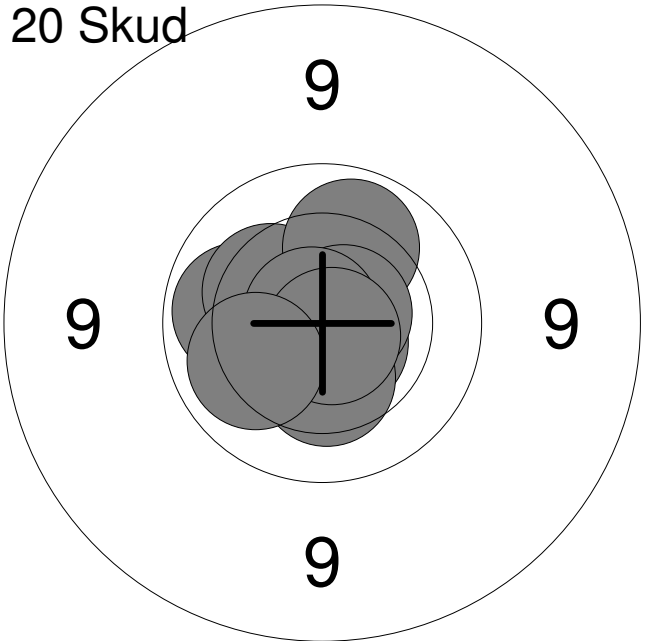
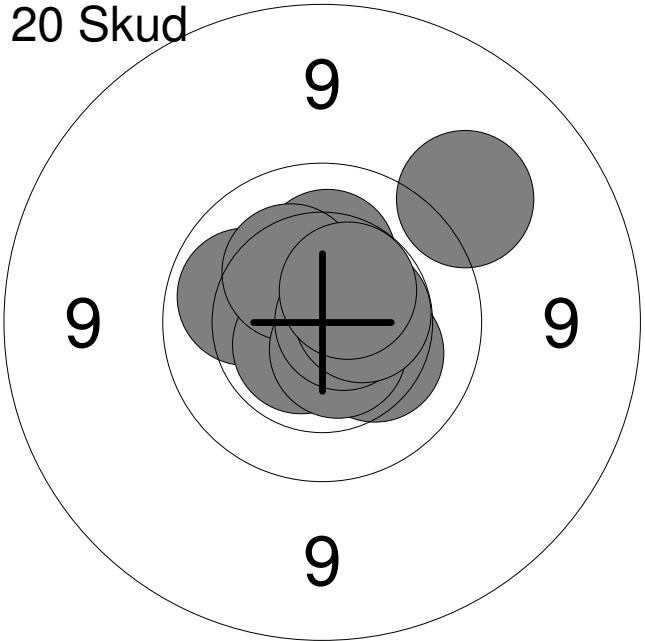
Hold <b>52</b>	Skive <b>7</b>	<b>Niclas Pedersen</b>		
Aalborg		Vilsted Skytteforening		MFRI
		Nordjysk mesterskab 2018	Aalborg Skyttekreds	
Prøve		1:	9.6	↗
		2:	10.7x	→
		3:	10.3	↗
		4:	10.5	↗
		5:	10.1	↖
		6:	10.2	←
		7:	10.4	←
		8:	10.6x	←
		Serie	79	
		Total	0	
20 Skud		1:	10.0	←
		2:	10.5x	↑
		3:	10.3	↖
		4:	10.1	↑
		5:	10.7x	↘
		6:	10.4	↓
		7:	10.7x	↗
		8:	10.8x	↖
		9:	10.8x	↘
		10:	10.1	↖
		Serie	100	
		Total	100	
20 Skud		11:	9.3	↗
		12:	10.1	←
		13:	10.6x	↘
		14:	10.3	↘
		15:	10.2	↑
		16:	10.3	↗
		17:	10.6x	↘
		18:	10.7x	→
		19:	10.5x	→
		20:	10.5x	↗
		Serie	99	
		Total	199	

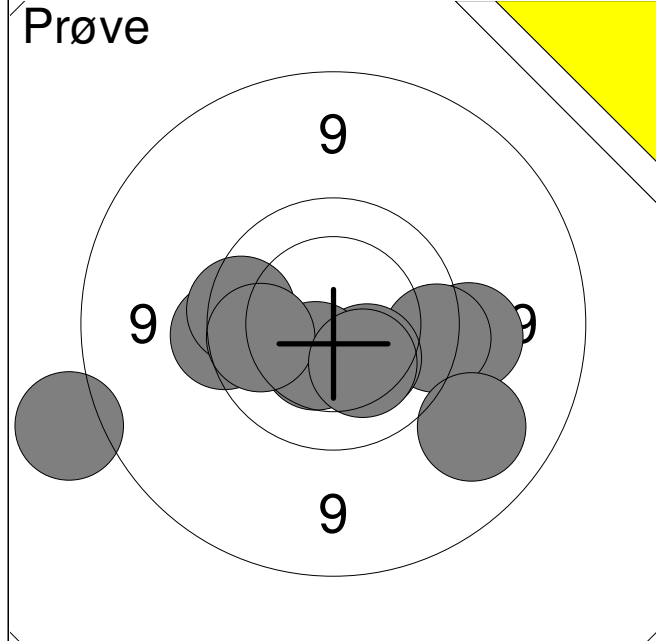

1:	9.7	←
2:	9.4	→
3:	9.7	→
4:	9.8	←
5:	10.3	↓
6:	8.5	←
7:	9.2	↓
8:	10.4	↓
9:	9.9	←
10:	10.3	↓
<b>Serie</b>		<b>92</b>
<b>Total</b>		<b>0</b>

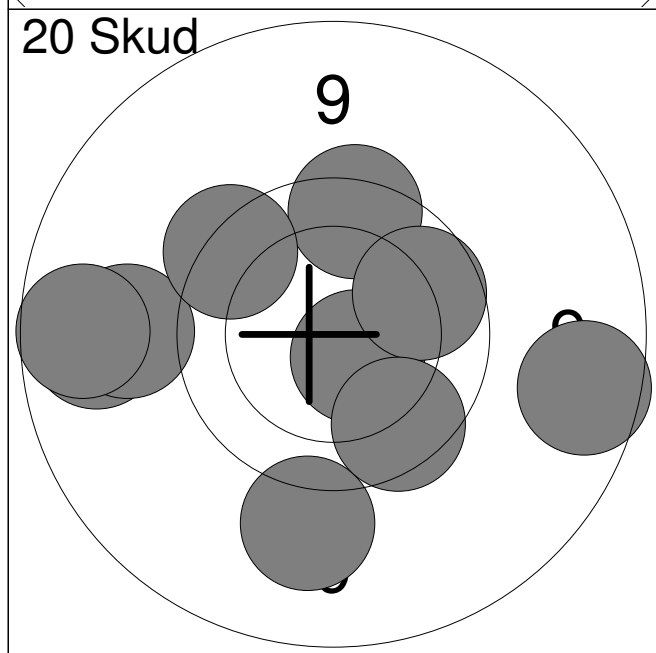

1:	9.0	←
2:	9.7	↑
3:	10.6x	↓
4:	9.9	→
5:	9.3	↓
6:	8.9	→
7:	9.2	←
8:	9.8	↓
9:	9.7	↗
10:	8.9	←
<b>Serie</b>		<b>89</b>
<b>Total</b>		<b>89</b>

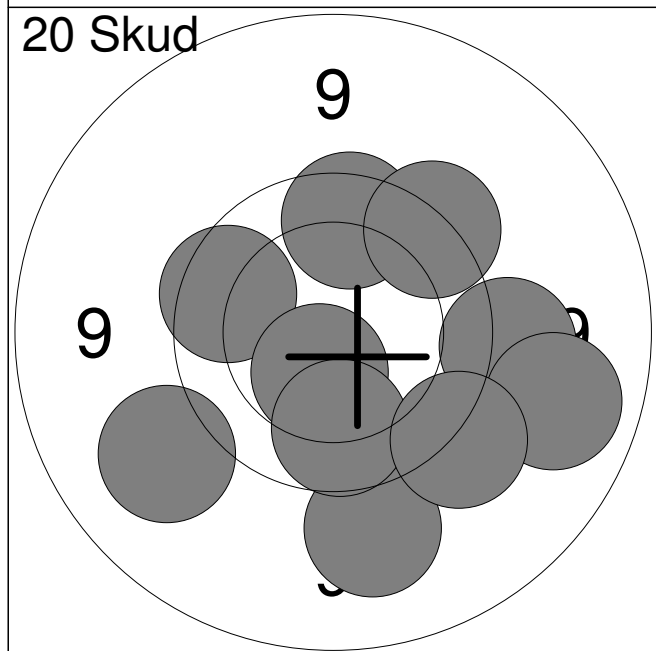

11:	9.8	←
12:	9.8	↑
13:	10.5	↓
14:	9.3	↓
15:	9.9	↓
16:	9.4	→
17:	9.1	→
18:	9.6	↗
19:	9.2	←
20:	9.5	↓
<b>Serie</b>		<b>91</b>
<b>Total</b>		<b>180</b>



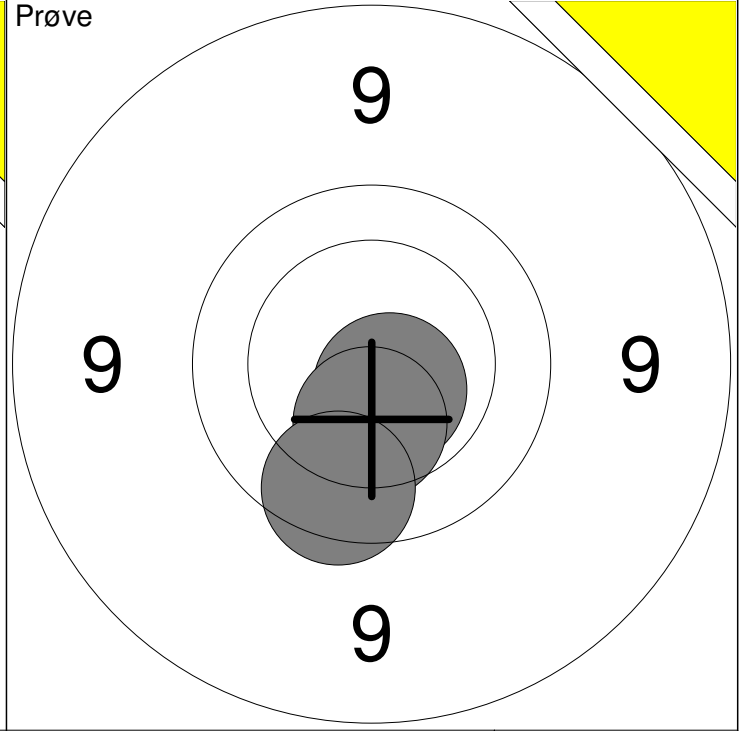
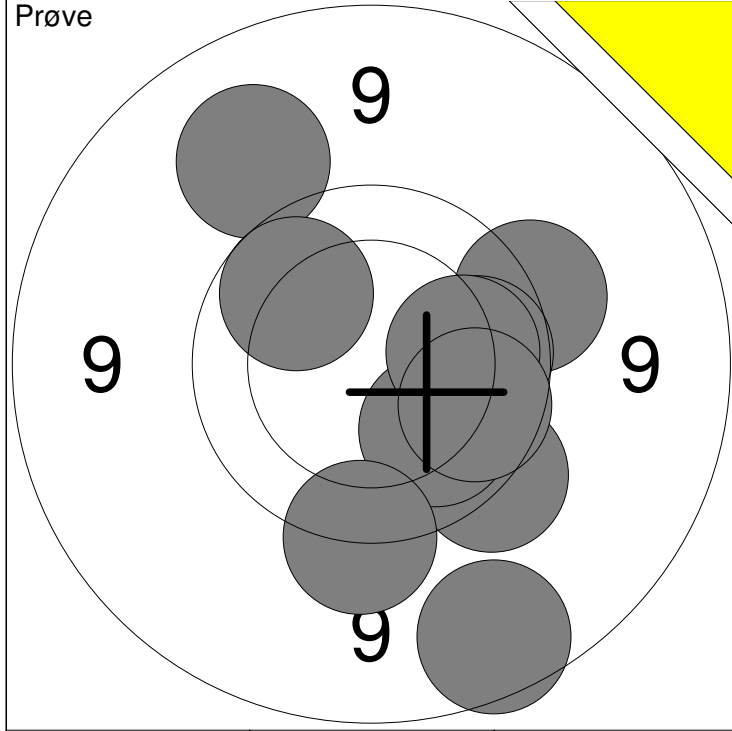

1: 8.9 ↘	6: 9.9 →	Serie	91
2: 9.6 ↘	7: 10.0 →		
3: 9.2 ↗	8: 9.9 ↘	Total	0
4: 10.0 ↘	9: 9.6 ↓		
5: 9.6 ↗	10: 9.9 ↗		

11: 10.6x ↘	Serie	29
12: 10.4 ↓		
13: 9.8 ↓	Total	0

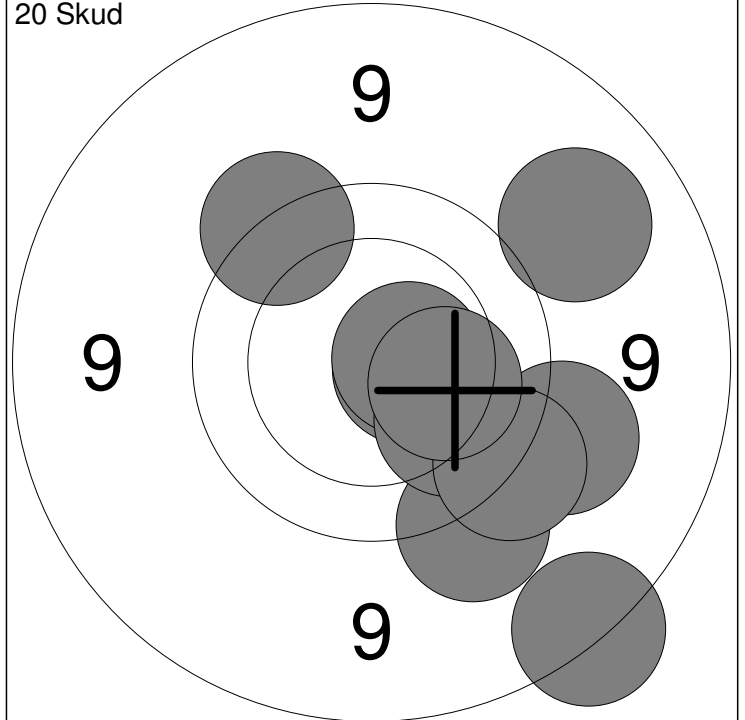
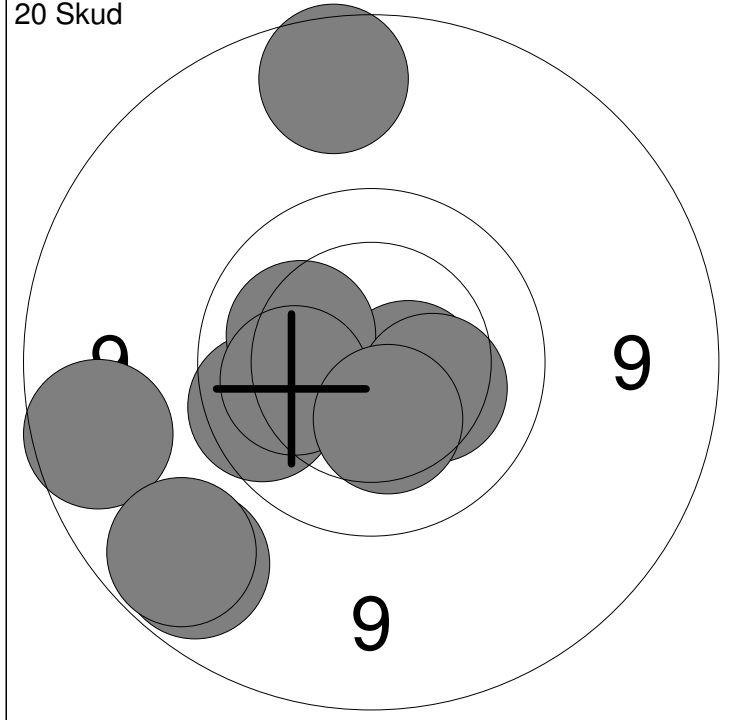

1: 9.8 ←	6: 9.0 ↘	Serie	93
2: 10.6x →	7: 10.3 →		
3: 10.2 ←	8: 10.2 ←	Total	93
4: 8.9 ←	9: 10.4 ↓		
5: 8.9 ↑	10: 9.0 ↘		

11: 8.7 ↘	16: 10.6x →	Serie	93
12: 9.4 →	17: 10.0 ↓		
13: 10.6x →	18: 9.6 ↗	Total	186
14: 9.4 ↓	19: 9.6 ↓		
15: 9.2 ↗	20: 10.2 →		

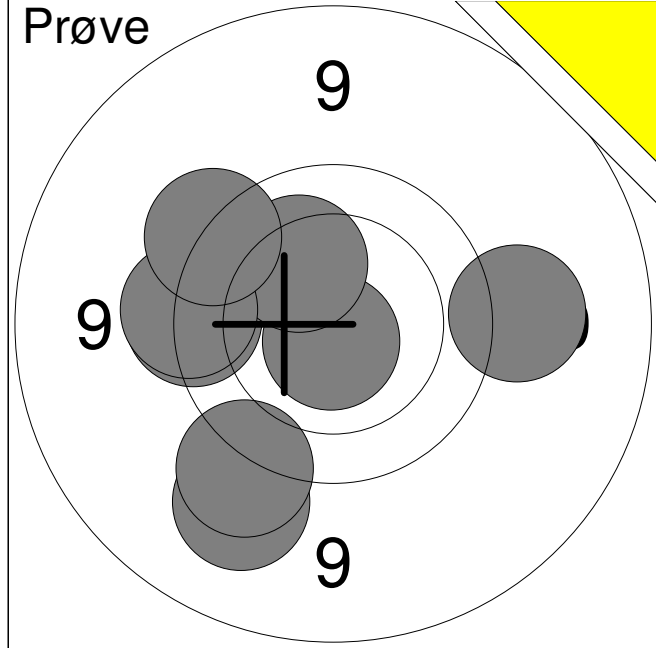

1:	9.3	↘
2:	10.8x	↓
3:	9.6	←
4:	10.2	↗
5:	9.4	→
6:	9.6	←
7:	9.5	↘
8:	9.6	↗
<b>Serie</b>		<b>74</b>
<b>Total</b>		<b>0</b>

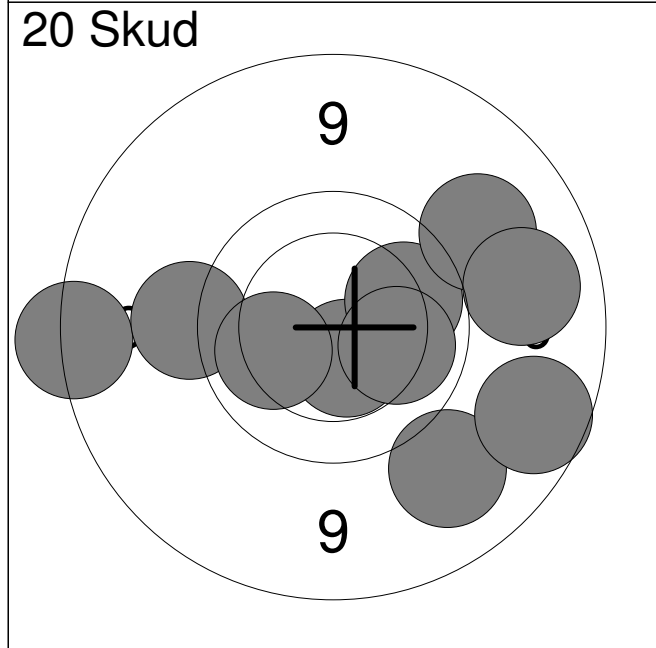

1:	8.7	←
2:	10.5x	↓
3:	10.0	→
4:	9.3	↗
5:	9.5	←
6:	9.2	↘
7:	10.1	←
8:	8.9	↘
9:	9.1	→
10:	10.1	→
<b>Serie</b>		<b>92</b>
<b>Total</b>		<b>92</b>

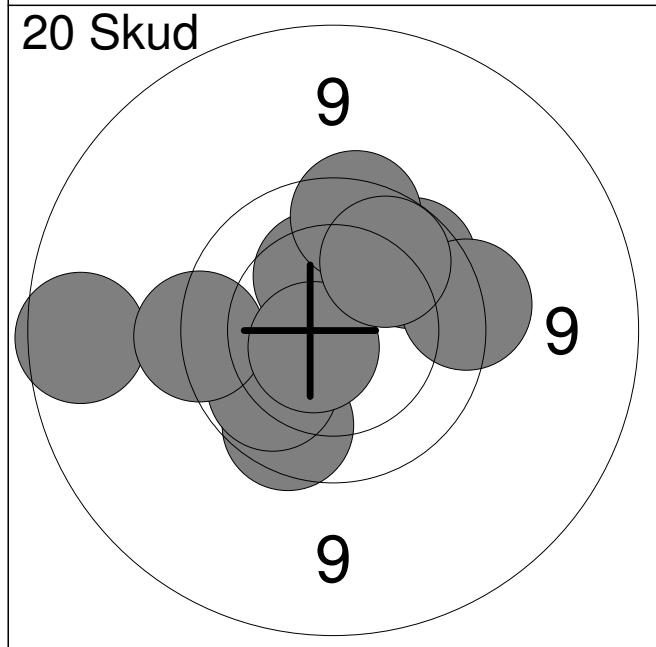

11:	10.3	↑
12:	9.8	↗
13:	9.8	↑
14:	9.8	↓
15:	8.9	←
16:	10.0	↘
17:	9.6	←
18:	9.6	→
19:	10.7x	↘
20:	10.0	↗
<b>Serie</b>		<b>93</b>
<b>Total</b>		<b>185</b>

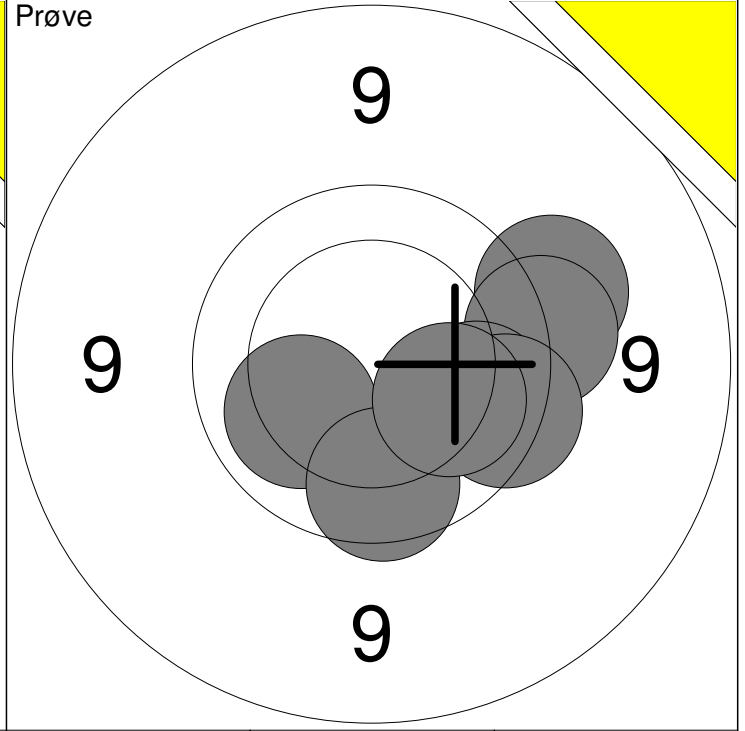
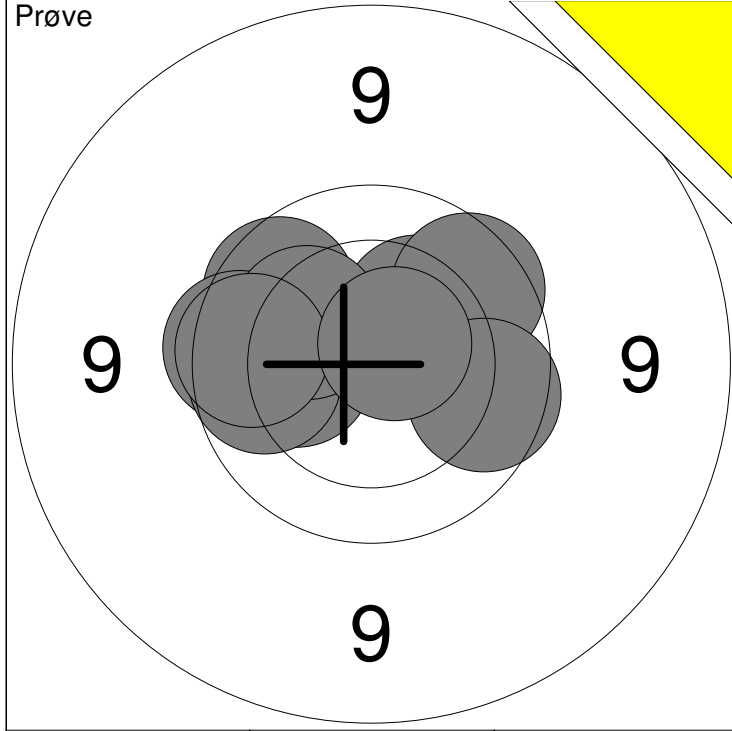

1: 10.3 ↗	6: 9.9 ←	Serie	94
2: 10.2 ←	7: 9.9 →		
3: 9.9 ↗	8: 10.2 ↖	Total	0
4: 9.8 ←	9: 9.8 ←		
5: 9.8 ↗	10: 10.6x ↗		

11: 9.4 ↗	16: 9.7 →	Serie	65
12: 10.1 ←	17: 10.1 →		
13: 9.8 ↓		Total	0
14: 9.6 →			
15: 9.9 →			

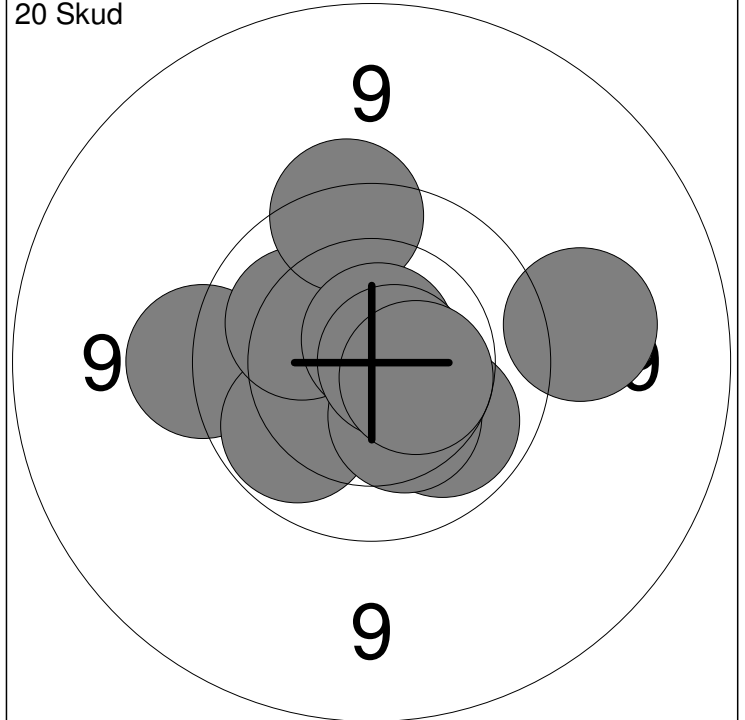
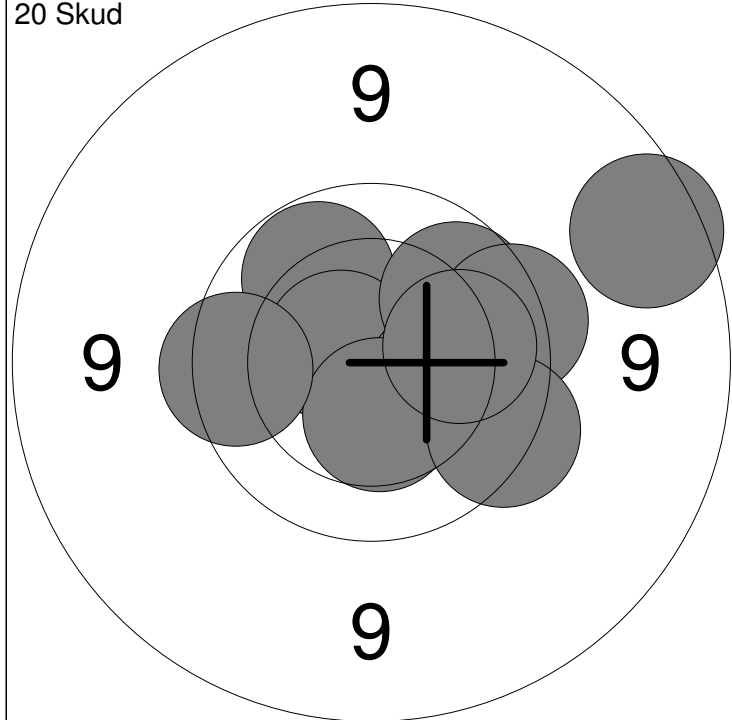

1: 10.0 ↗	6: 9.9 ↗	Serie	94
2: 10.6x ↖	7: 8.9 →		
3: 10.2 →	8: 9.7 →	Total	94
4: 10.4 ↓	9: 9.7 ↘		
5: 9.8 ←	10: 10.1 →		

11: 9.6 ←	16: 10.3 ↓	Serie	97
12: 10.1 ↘	17: 10.7x ↗		
13: 10.0 ←	18: 9.3 →	Total	191
14: 10.2 ↖	19: 10.7x →		
15: 9.7 ↗	20: 10.5 →		

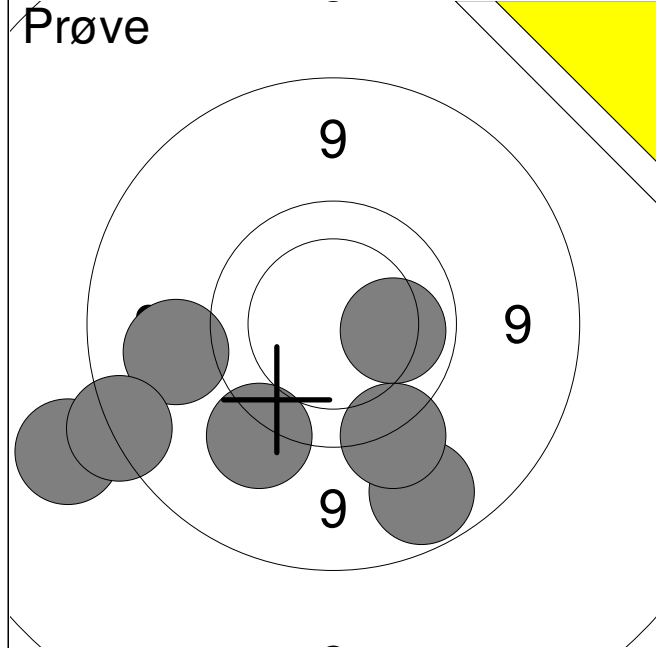

1:	9.2	←
2:	8.4	←
3:	9.4	↓
4:	8.7	←
5:	10.1	→
6:	9.0	↓
7:	9.5	↓
<b>Serie</b>		<b>62</b>
<b>Total</b>		<b>0</b>

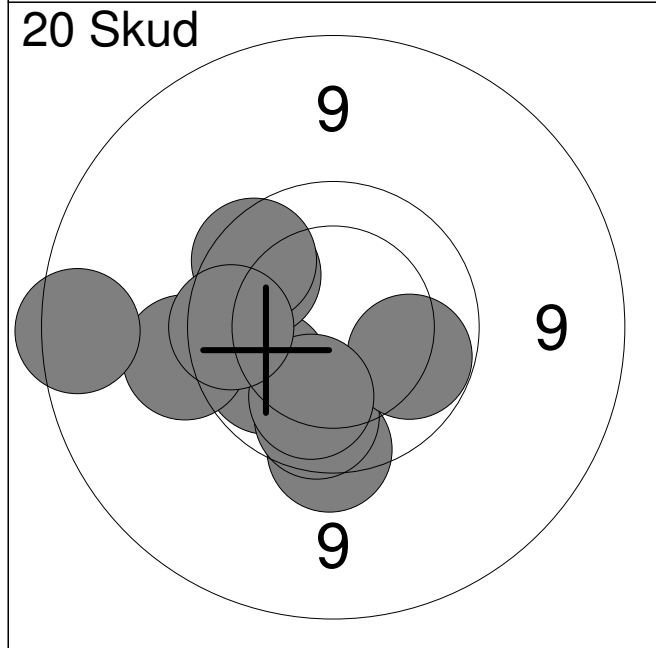

1:	10.0	←
2:	9.7	↓
3:	9.9	↓
4:	9.5	←
5:	9.9	↗
6:	9.8	↗
7:	10.0	→
8:	10.1	↓
9:	8.8	←
10:	9.8	←
<b>Serie</b>		<b>92</b>
<b>Total</b>		<b>92</b>

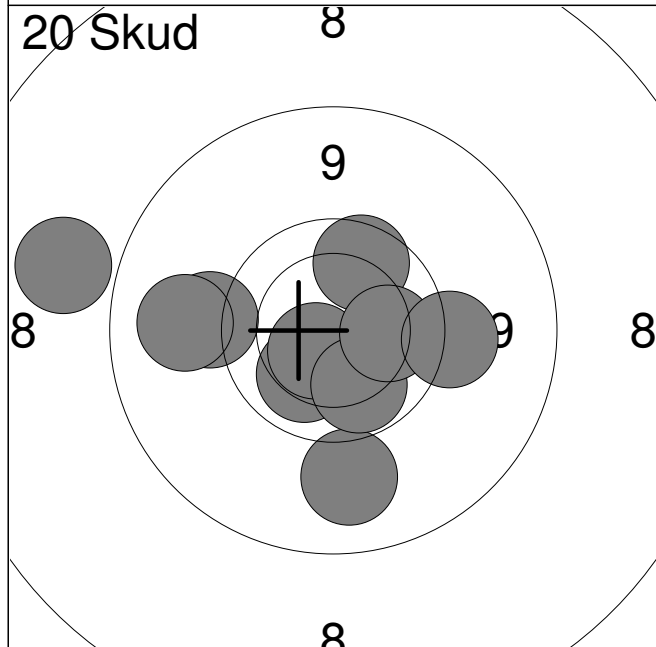

11:	10.1	↓
12:	8.4	←
13:	10.5x	↓
14:	9.2	↓
15:	9.4	←
16:	10.0	↓
17:	9.9	↗
18:	10.1	→
19:	9.5	→
20:	9.2	←
<b>Serie</b>		<b>93</b>
<b>Total</b>		<b>185</b>

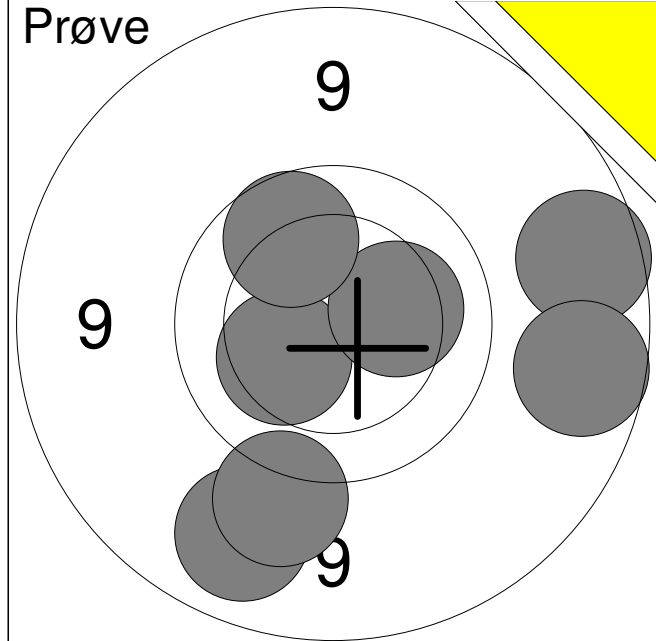

1:	9.1	↘
2:	8.9	→
3:	9.4	↘
4:	10.3	←
5:	10.2	→
6:	9.9	↗
7:	8.9	→
<b>Serie</b>		<b>63</b>
<b>Total</b>		<b>0</b>

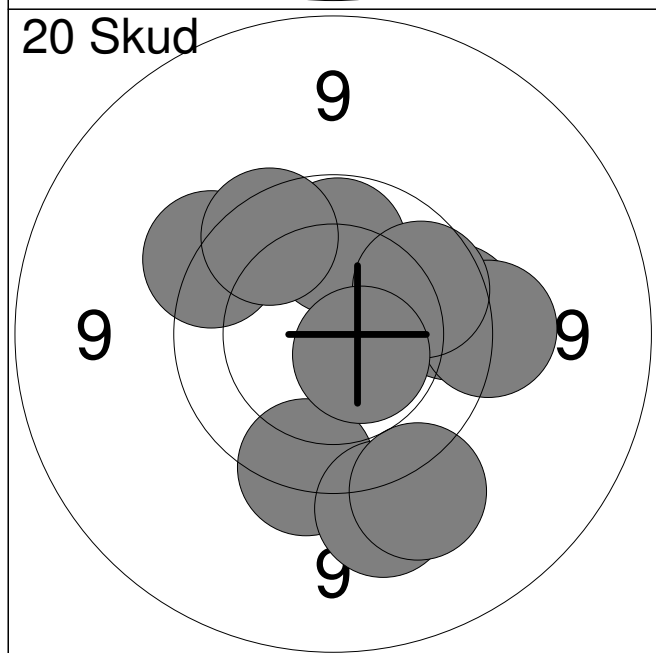

1:	9.8	→
2:	9.5	→
3:	10.0	↑
4:	9.7	↘
5:	9.9	↗
6:	10.6x	↘
7:	9.4	↘
8:	9.6	↗
9:	9.8	↗
10:	9.4	↘
<b>Serie</b>		<b>92</b>
<b>Total</b>		<b>92</b>

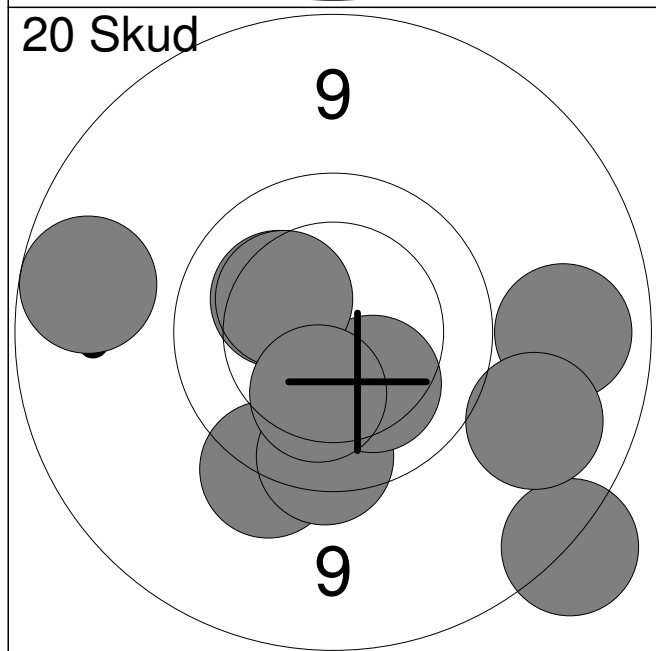

11:	9.6	↘
12:	8.9	←
13:	9.1	→
14:	9.7	↘
15:	10.2	↗
16:	10.2	↘
17:	10.3	↗
18:	8.7	↘
19:	9.1	↘
20:	10.3	↘
<b>Serie</b>		<b>92</b>
<b>Total</b>		<b>184</b>

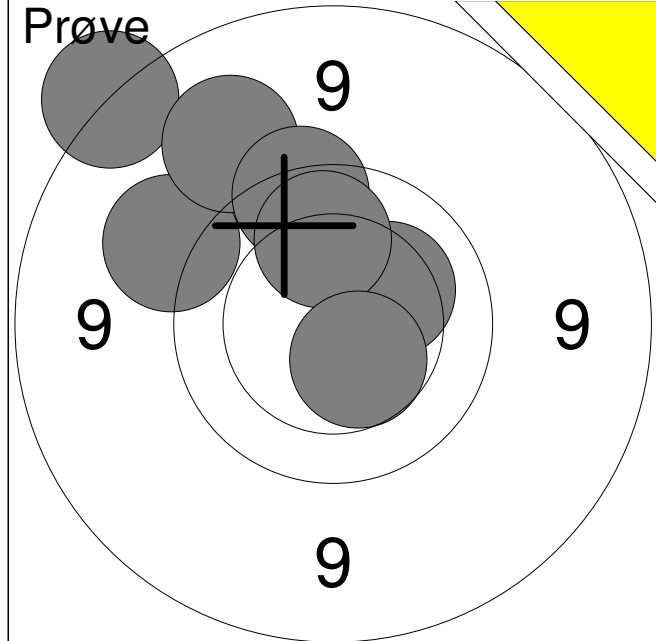

1:	8.7	↗
2:	9.4	↗
3:	9.2	↗
4:	9.7	↗
5:	10.2	↗
6:	10.0	↗
7:	10.5	↘
<b>Serie</b>		<b>65</b>
<b>Total</b>		<b>0</b>

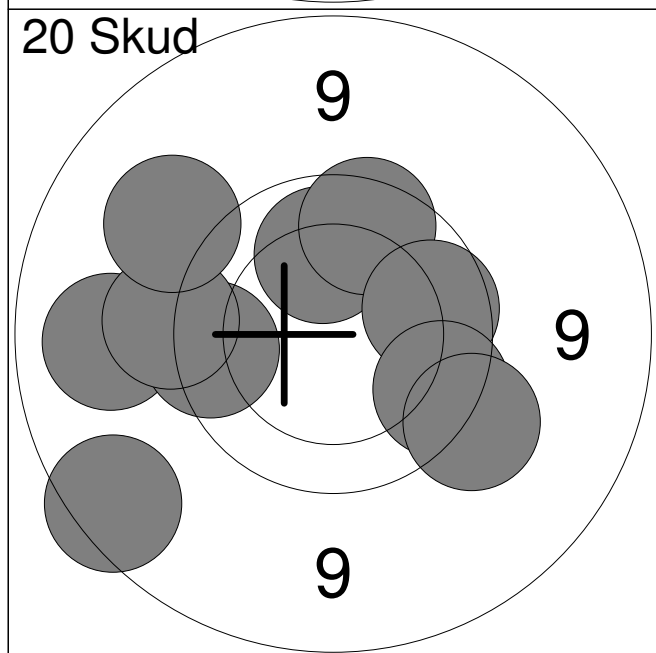

1:	9.1	←
2:	9.7	←
3:	9.5	←
4:	10.1	↗
5:	9.8	↗
6:	9.9	→
7:	9.8	↘
8:	9.5	↘
9:	8.8	↙
10:	9.3	↗
<b>Serie</b>		<b>90</b>
<b>Total</b>		<b>90</b>

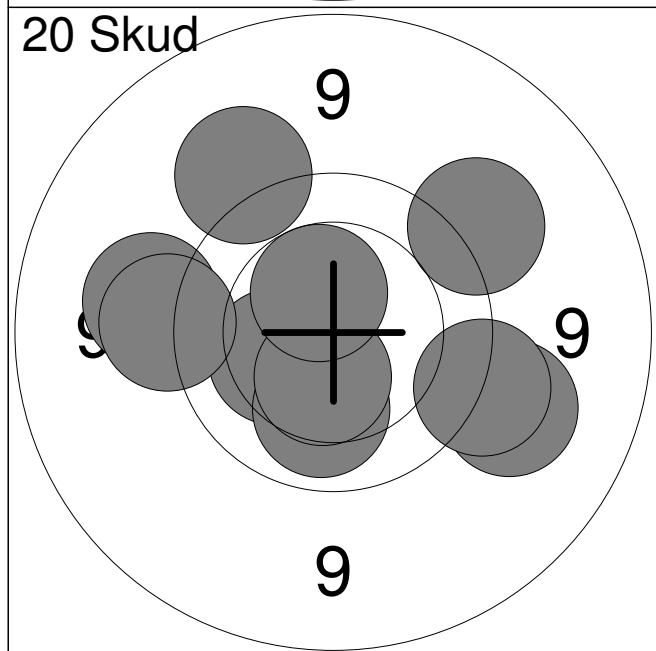

11:	9.4	↗
12:	9.4	↗
13:	9.3	↘
14:	9.4	←
15:	10.3	←
16:	10.1	↘
17:	10.4	↘
18:	9.5	←
19:	9.5	→
20:	10.5	↗
<b>Serie</b>		<b>94</b>
<b>Total</b>		<b>184</b>

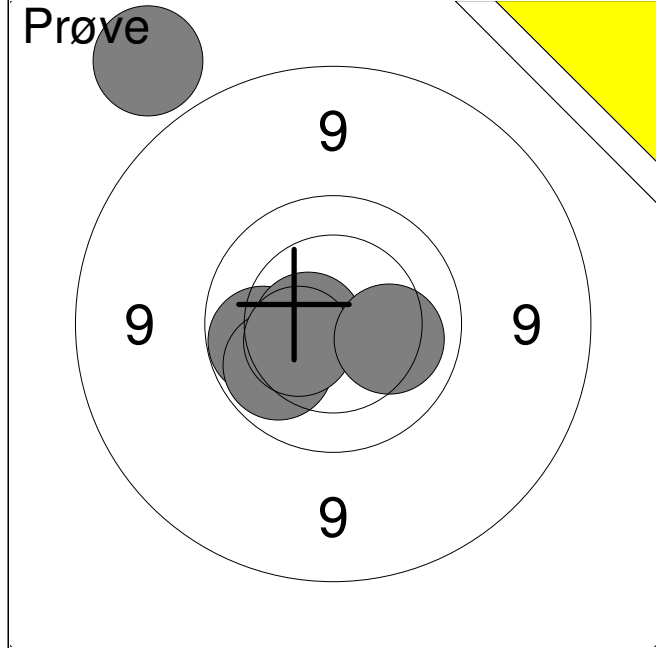

1:	8.3	↗
2:	10.0	←
3:	10.0	↙
4:	10.6x	←
5:	10.4	↙
6:	10.2	→
<b>Serie</b>		<b>58</b>
<b>Total</b>		<b>0</b>

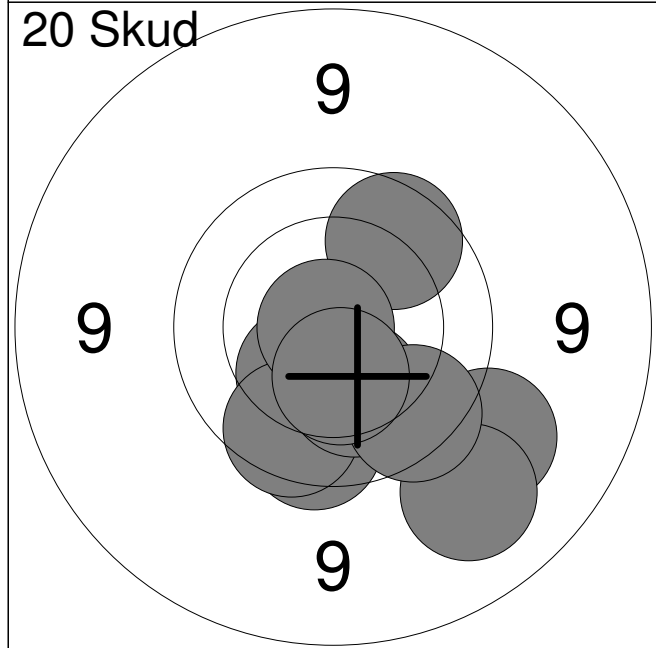

1:	10.4	↙
2:	9.3	↘
3:	9.2	↘
4:	9.8	↘
5:	9.8	↘
6:	10.2	↘
7:	9.9	↗
8:	9.8	↘
9:	10.9x	←
10:	10.4	↘
<b>Serie</b>		<b>94</b>
<b>Total</b>		<b>94</b>

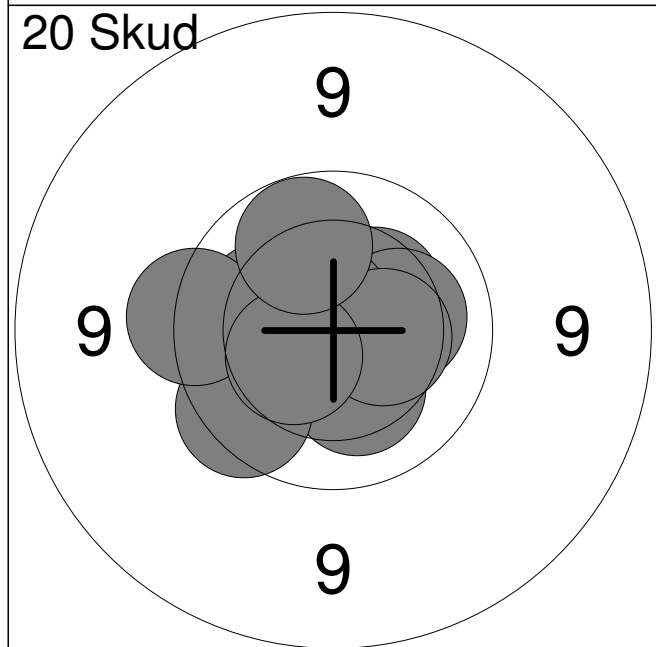

11:	10.3	↗
12:	10.3	↘
13:	10.2	→
14:	10.7x	↗
15:	10.2	←
16:	9.8	↙
17:	10.4	→
18:	9.6	←
19:	10.4	↙
20:	10.0	↗
<b>Serie</b>		<b>98</b>
<b>Total</b>		<b>192</b>

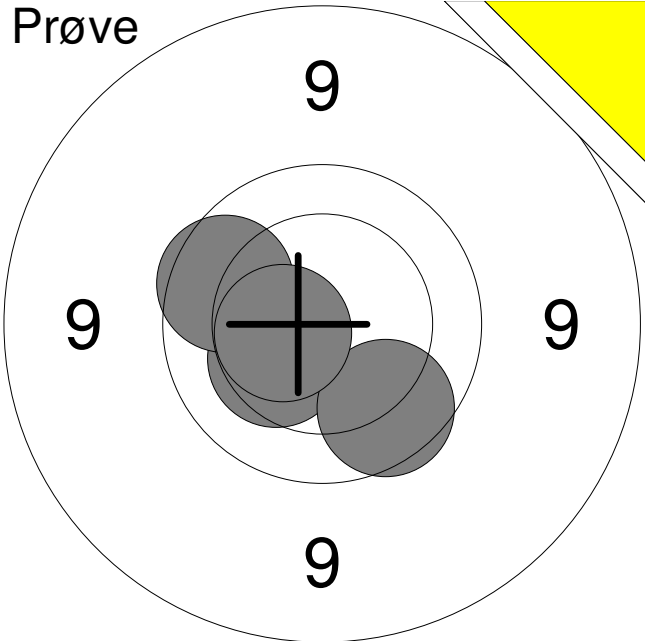
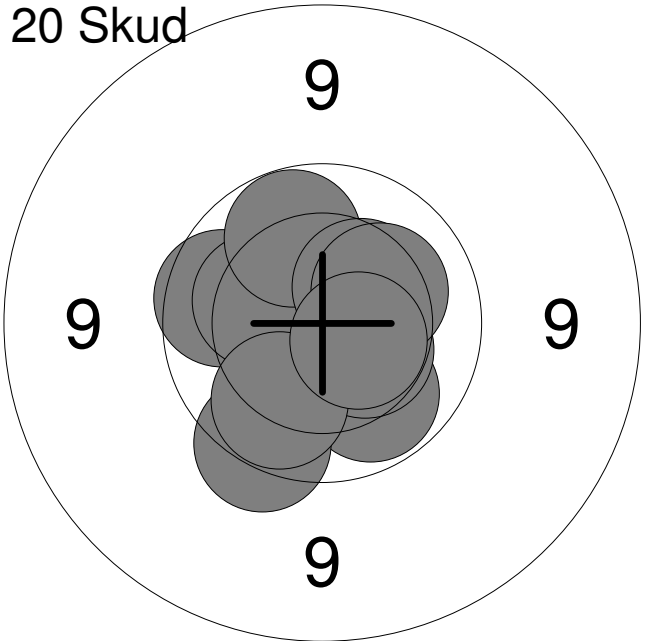
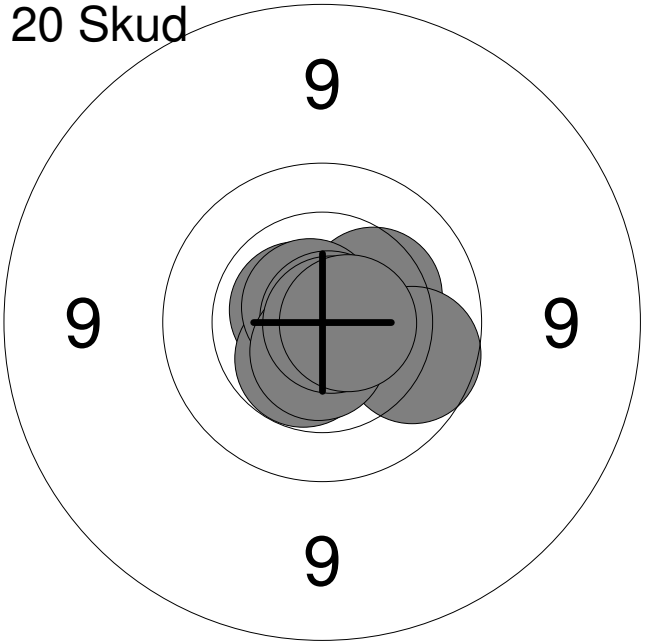
Hold	Skive	Rasmus Møller Larsen	
53	4	Aalborg	Vilsted Skytteforening
		Nordjysk mesterskab 2018	MVÅ1
			Aalborg Skyttekreds
Prøve		1: 10.3	↙
		2: 9.9	↖
		3: 9.9	↘
		4: 10.5x	↖
		<b>Serie</b>	<b>38</b>
		<b>Total</b>	<b>0</b>
20 Skud		1: 9.9	↖
		2: 10.2	↖
		3: 10.0	↗
		4: 10.0	↘
		5: 10.4	↗
		6: 10.4	↘
		7: 10.2	↗
		8: 9.7	↘
		9: 10.0	↘
		10: 10.5x	↘
		<b>Serie</b>	<b>98</b>
		<b>Total</b>	<b>98</b>
20 Skud		11: 10.7x	↖
		12: 10.6x	↖
		13: 10.5x	↘
		14: 10.3	↗
		15: 9.9	↘
		16: 10.7x	↗
		17: 10.9x	↗
		18: 10.6x	↘
		19: 10.8x	↘
		20: 10.7x	→
		<b>Serie</b>	<b>99</b>
		<b>Total</b>	<b>197</b>



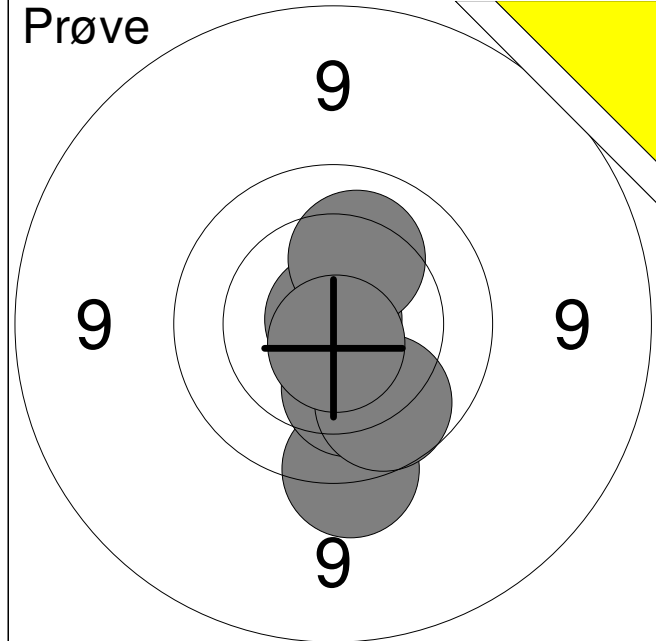

1:	9.6	↓
2:	10.2	↓
3:	9.9	↓
4:	10.9x	↑
5:	10.2	↑
6:	10.7x	↓
<b>Serie</b>		<b>58</b>
<b>Total</b>		<b>0</b>

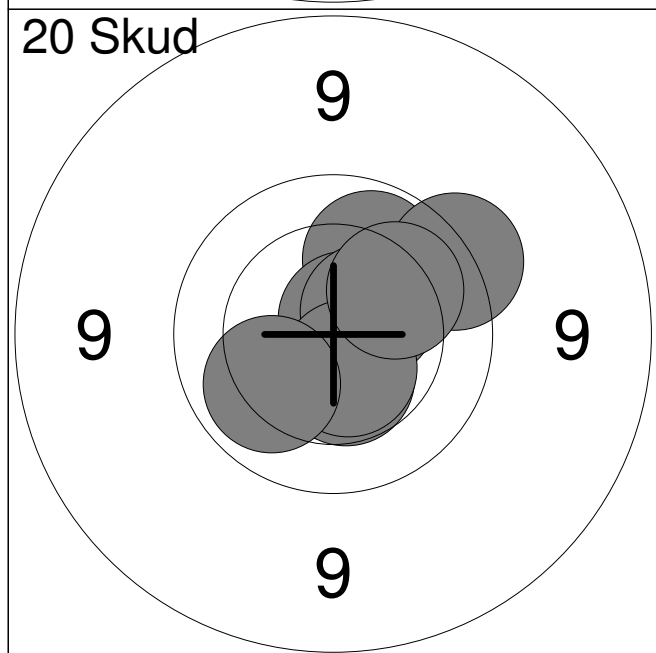

1:	10.0	↗
2:	9.6	↗
3:	10.6x	↓
4:	10.5x	↓
5:	10.7x	↗
6:	10.5	↓
7:	10.5	↗
8:	10.5x	↓
9:	10.1	↙
10:	10.1	↗
<b>Serie</b>		<b>99</b>
<b>Total</b>		<b>99</b>

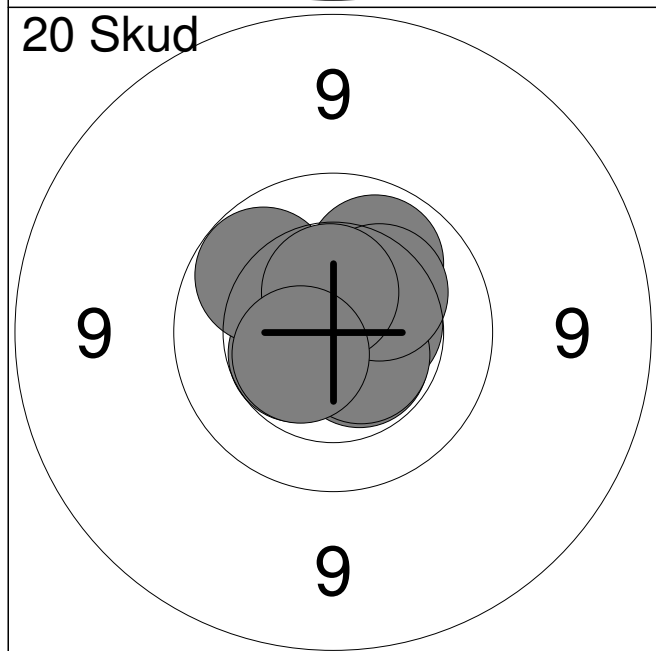

11:	10.5x	↘
12:	10.5	→
13:	10.8x	↓
14:	10.6x	↘
15:	10.5	↙
16:	10.0	↗
17:	10.1	↗
18:	10.3	↗
19:	10.5x	↑
20:	10.5x	↙
<b>Serie</b>		<b>100</b>
<b>Total</b>		<b>199</b>

**Prøve**

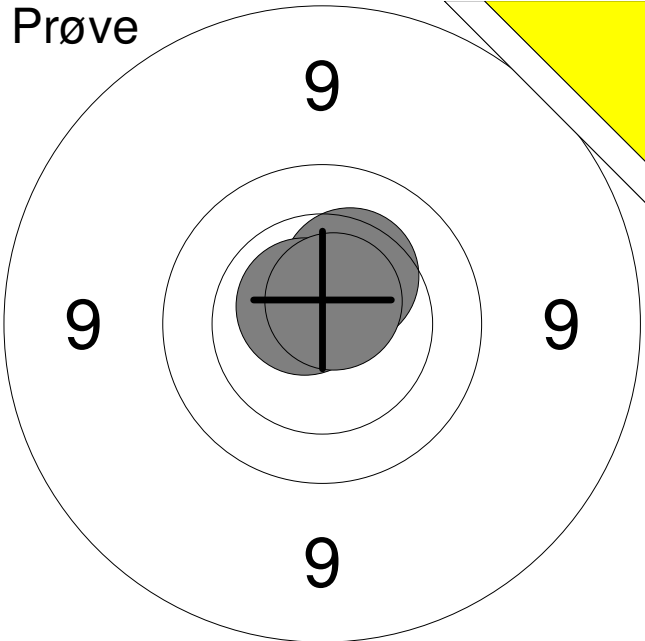

1:	10.3	↗
2:	10.7x	↖
3:	10.7x	↗

Serie	30
Total	0

**20 Skud**

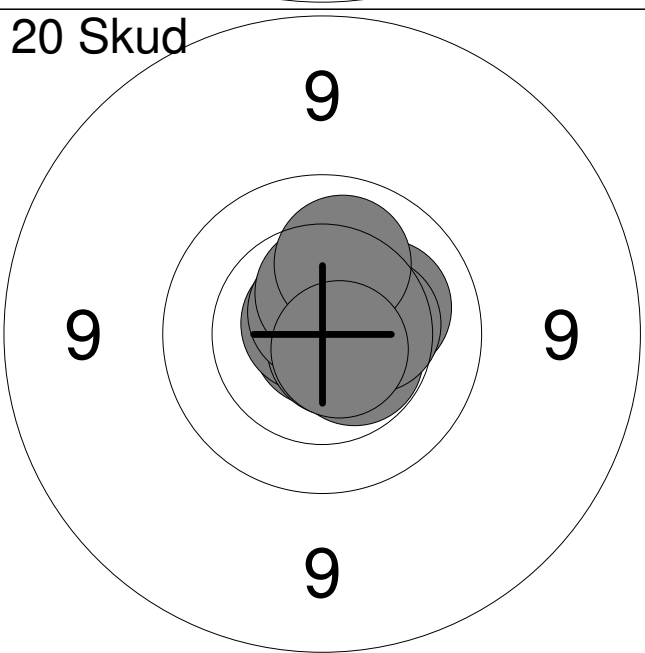

1:	10.2	↗
2:	10.5x	↘
3:	10.9x	↘
4:	10.8x	↗
5:	10.4	→
6:	10.7x	↘
7:	10.7x	↗
8:	10.5x	↗
9:	10.1	↗
10:	10.7x	↘

Serie	100
Total	100

**20 Skud**

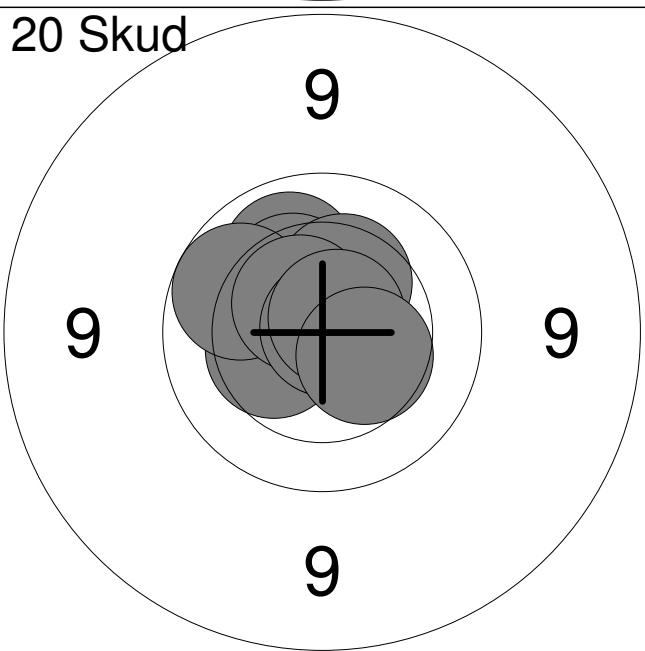

11:	10.4	↖
12:	10.1	↗
13:	10.3	↗
14:	9.9	↖
15:	10.4	↗
16:	10.6x	↗
17:	10.9x	→
18:	10.9x	↗
19:	10.7x	↗
20:	10.4	↘

Serie	99
Total	199

**Prøve**

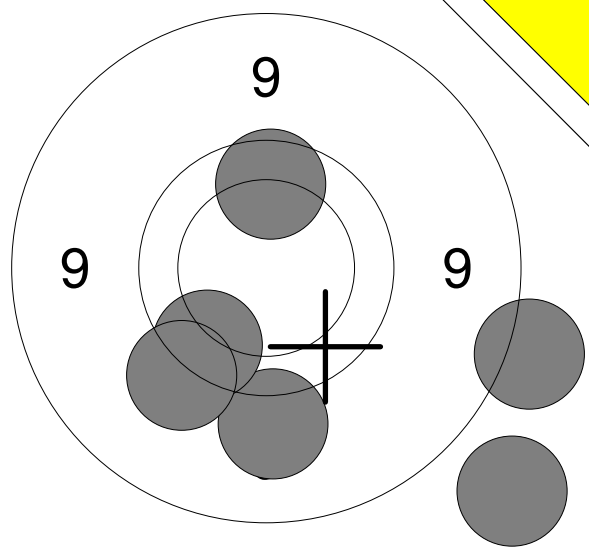

1:	8.3	↘
2:	9.3	↓
3:	9.8	↙
4:	8.6	→
5:	9.4	↙
6:	9.9	↑

Serie 52

Total 0

**20 Skud**

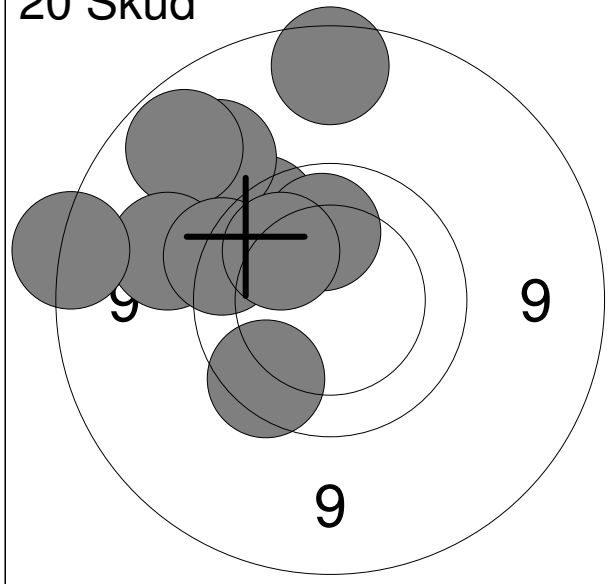

1:	9.7	↗
2:	9.8	↙
3:	9.2	↗
4:	10.1	↑
5:	8.9	↑
6:	9.0	↗
7:	9.3	↖
8:	9.7	↖
9:	10.1	↗
10:	8.7	←

Serie 90

Total 90

**20 Skud**

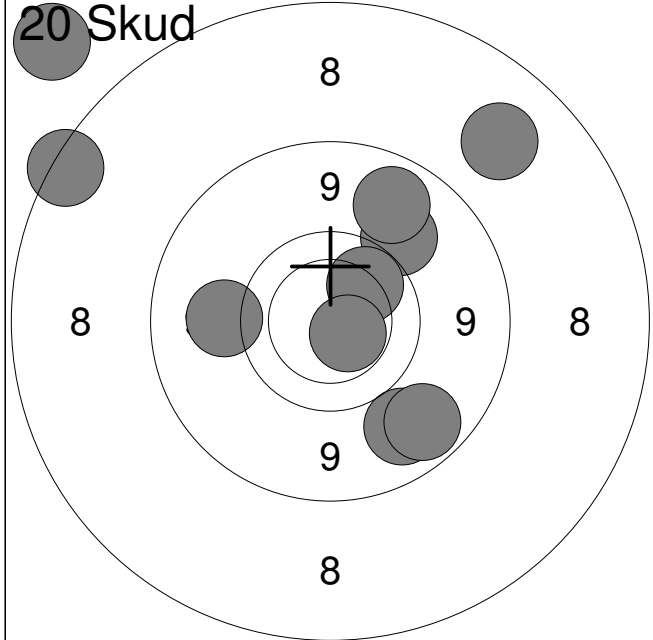

11:	9.1	↘
12:	9.3	↗
13:	7.1	↗
14:	10.0	↗
15:	9.0	↘
16:	10.5x	↘
17:	8.2	↗
18:	9.3	←
19:	7.8	↖
20:	9.1	↗

Serie 87

Total 177

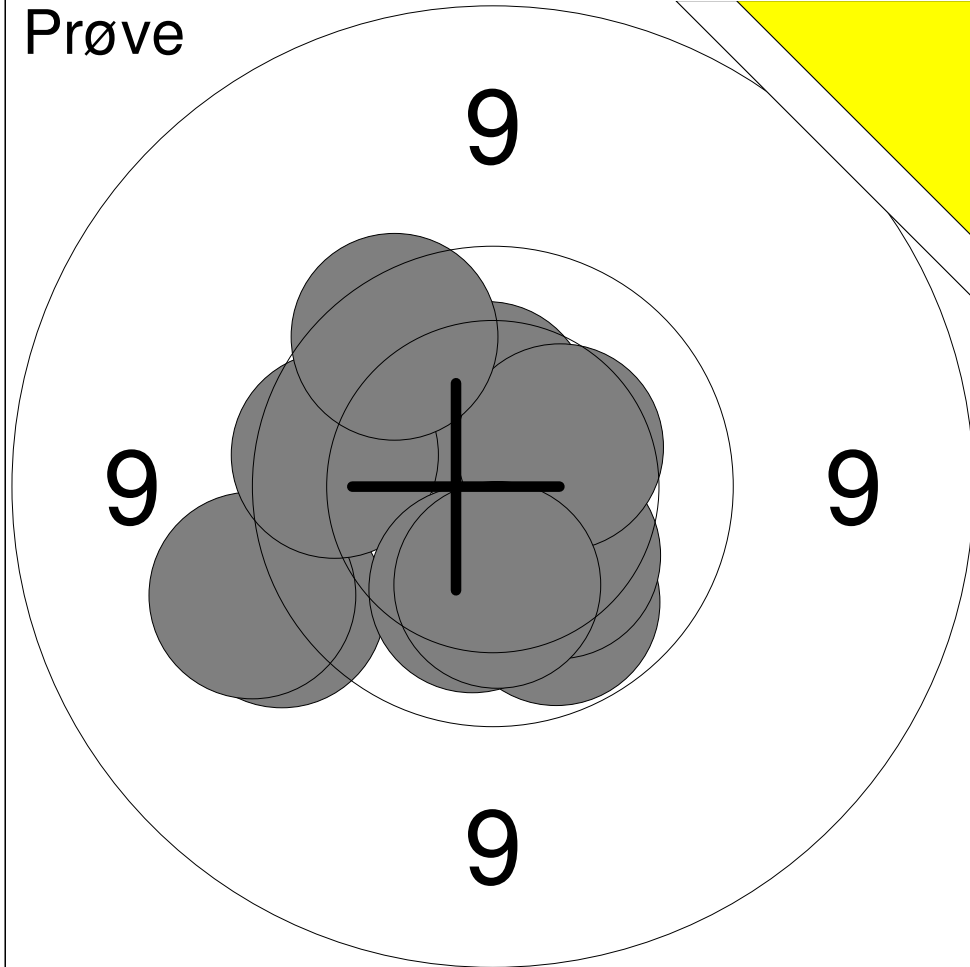

1:	10.0	↘
2:	10.3	↘
3:	10.4	↑
4:	9.5	↙
5:	9.4	↙
6:	9.8	↙
7:	10.2	↘
8:	10.4	↗
9:	10.2	↓
10:	9.8	↖

Serie	96
Total	0

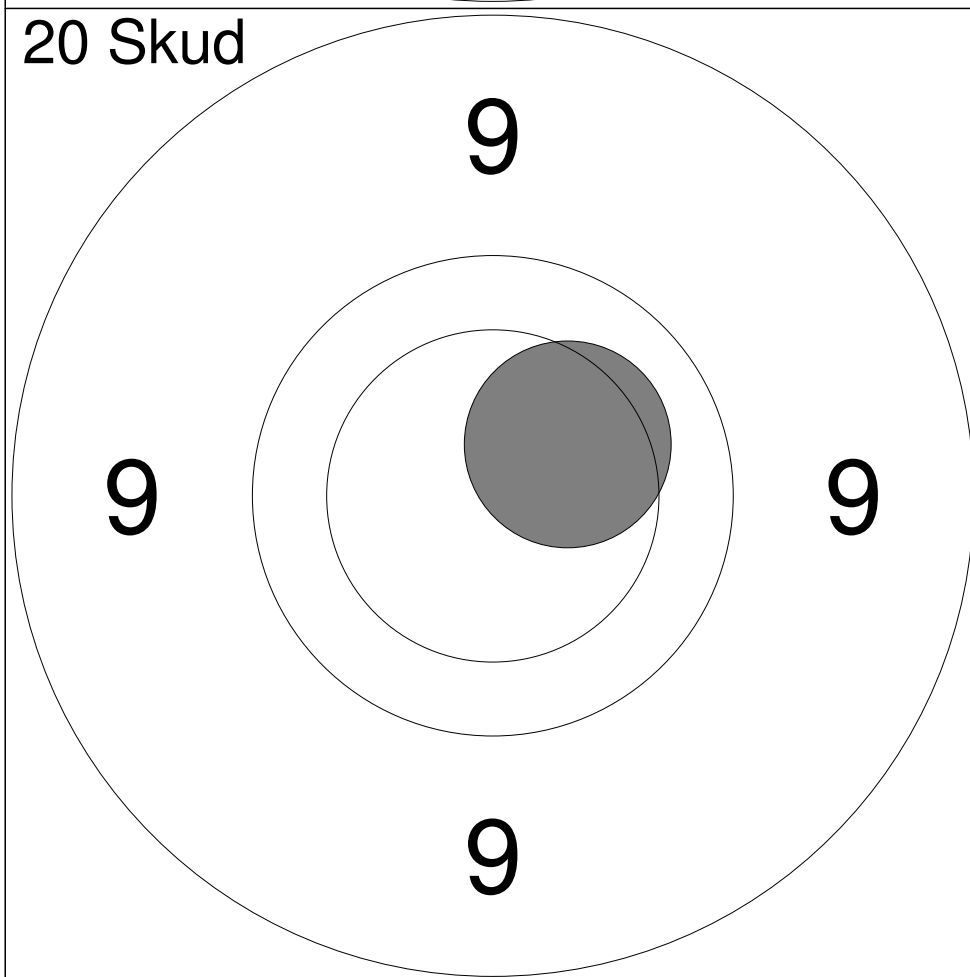

1:	10.3	↗
----	------	---

Serie	10
Total	10

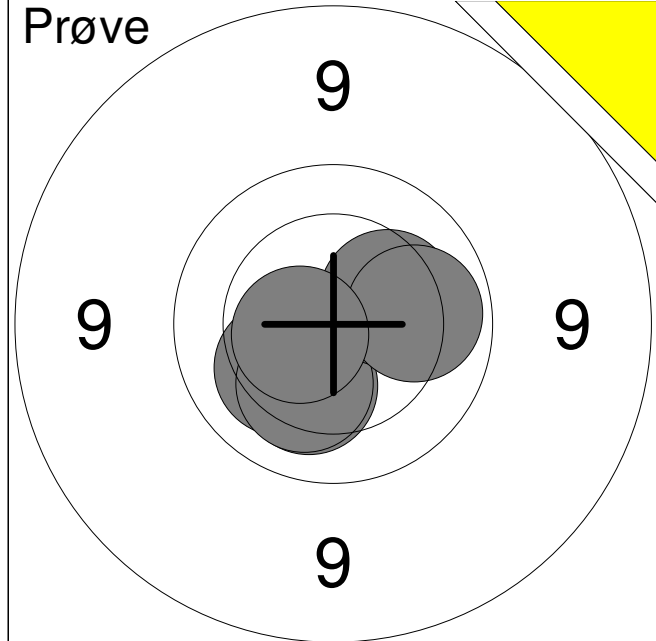

1:	10.2	↓
2:	10.2	↙
3:	10.2	↓
4:	10.3	→
5:	10.1	→
6:	10.6x	←
<b>Serie</b>		<b>60</b>
<b>Total</b>		<b>0</b>

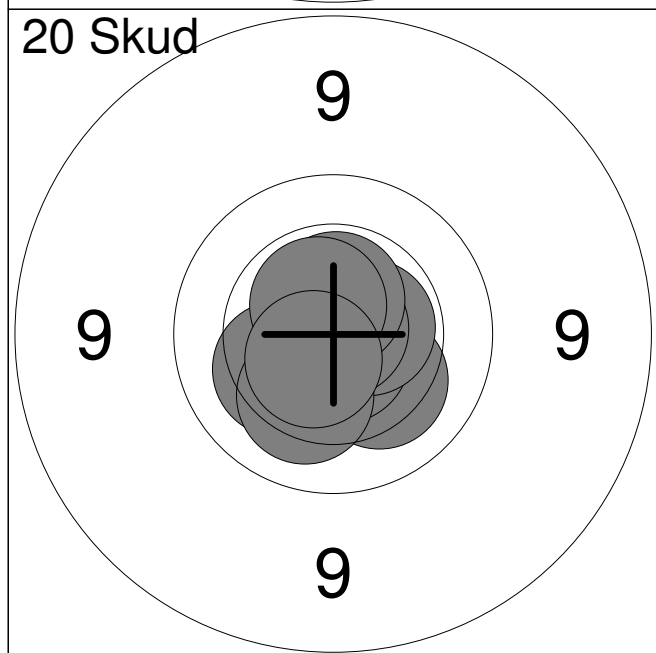

1:	10.2	↘
2:	10.3	↙
3:	10.7x	↑
4:	10.7x	↓
5:	10.6x	→
6:	10.9x	↗
7:	10.6x	↑
8:	10.6x	↗
9:	10.2	↓
10:	10.6x	↘
<b>Serie</b>		<b>100</b>
<b>Total</b>		<b>100</b>

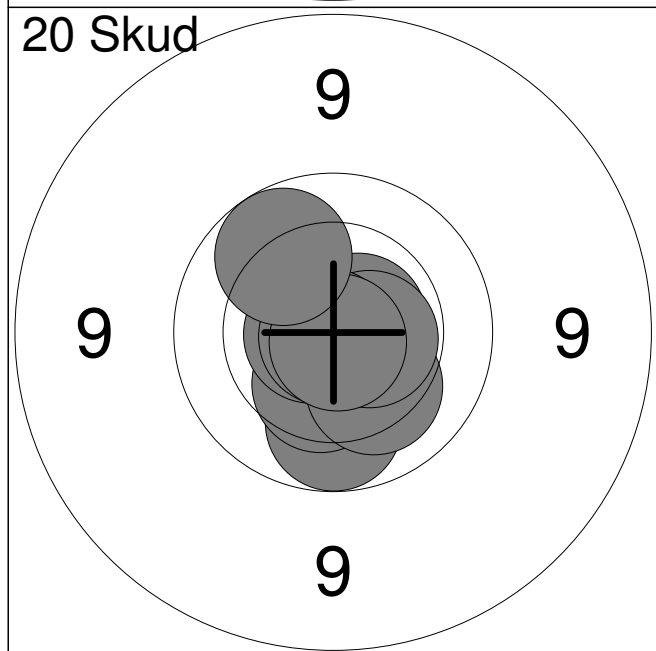

11:	10.9x	↘
12:	10.7x	→
13:	10.0	↓
14:	10.4	↓
15:	10.2	↘
16:	10.7x	←
17:	10.5x	→
18:	10.9x	↙
19:	10.8x	↘
20:	10.0	↗
<b>Serie</b>		<b>100</b>
<b>Total</b>		<b>200</b>

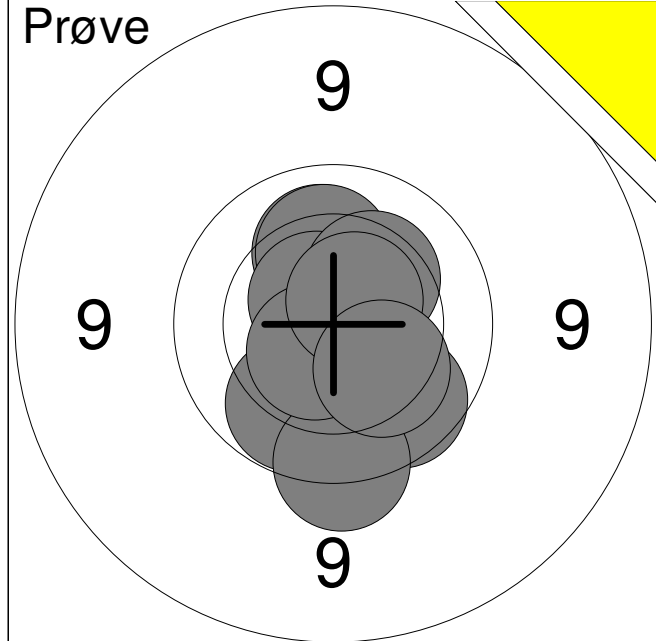

1:	10.2	↑
2:	10.0	↓
3:	10.2	↑
4:	9.9	↓
5:	9.7	↓
6:	10.6x	↗
7:	10.6x	↓
8:	10.3	↗
9:	10.6x	↗
10:	10.2	↓
<b>Serie</b>		<b>98</b>
<b>Total</b>		<b>0</b>

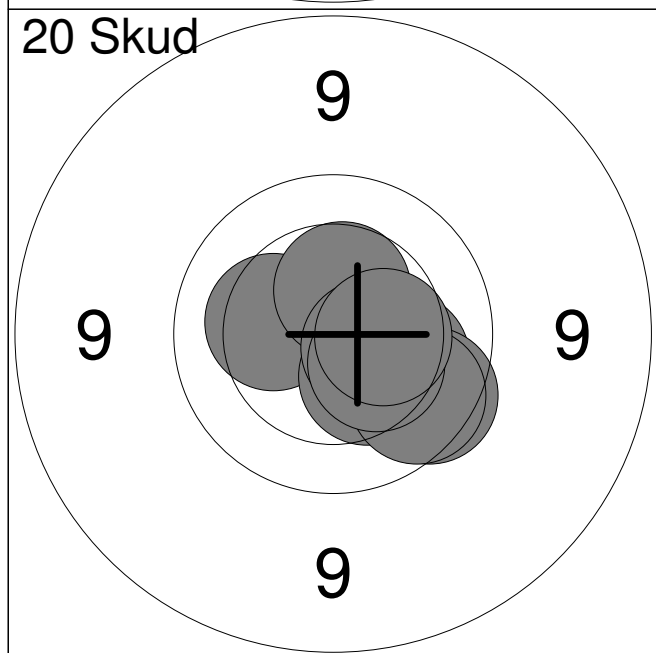

1:	10.1	↘
2:	10.7x	↗
3:	10.3	←
4:	10.5	↑
5:	10.4	↓
6:	9.8	↓
7:	10.5x	↘
8:	9.9	↓
9:	10.4	↓
10:	10.4	→
<b>Serie</b>		<b>98</b>
<b>Total</b>		<b>98</b>

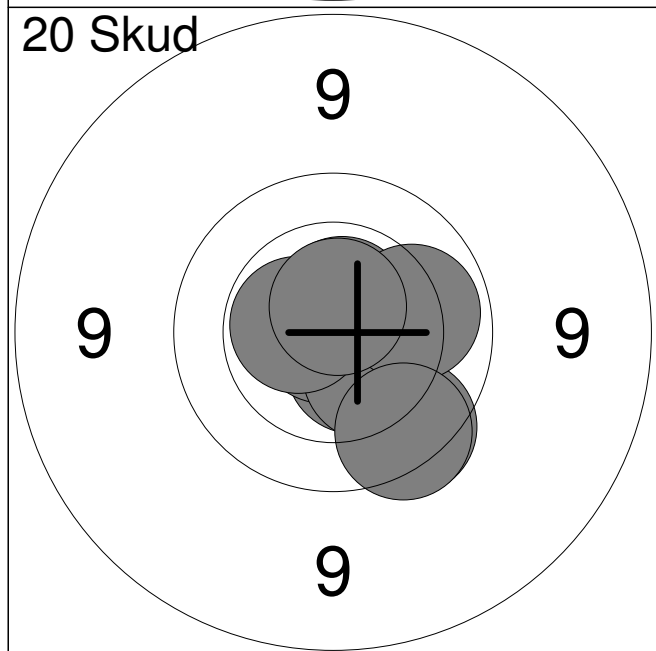

11:	10.5x	↓
12:	10.6x	↘
13:	10.6x	↑
14:	9.8	↓
15:	10.8x	←
16:	10.3	↓
17:	10.6x	←
18:	10.1	↘
19:	9.8	↓
20:	10.7x	↑
<b>Serie</b>		<b>98</b>
<b>Total</b>		<b>196</b>

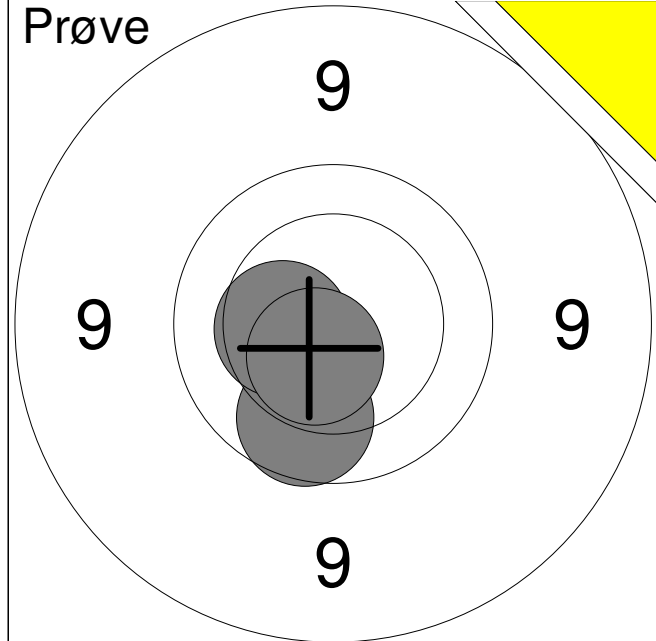

1:	9.9	↓
2:	10.4	←
3:	10.5x	↓
<b>Serie</b>		<b>29</b>
<b>Total</b>		<b>0</b>

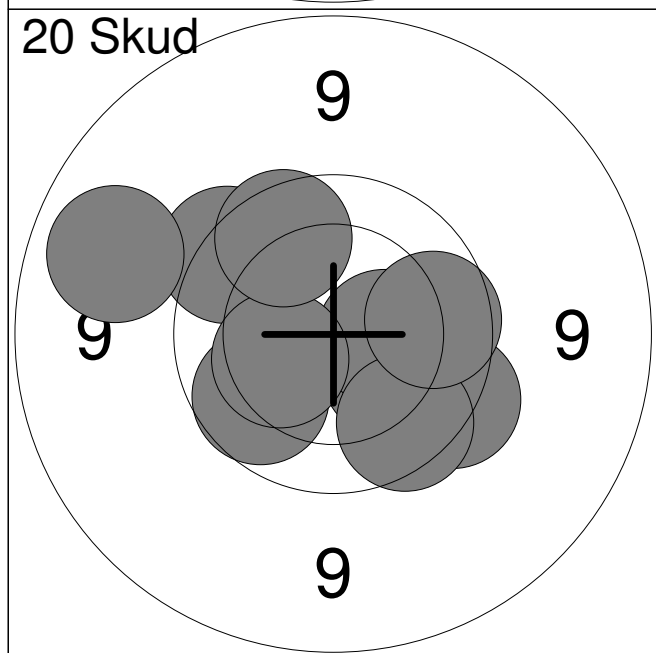

1:	9.7	↘
2:	10.2	↘
3:	9.7	↗
4:	10.4	→
5:	9.8	↘
6:	9.9	↙
7:	9.9	→
8:	10.3	←
9:	9.8	↗
10:	9.1	←
<b>Serie</b>		<b>93</b>
<b>Total</b>		<b>93</b>

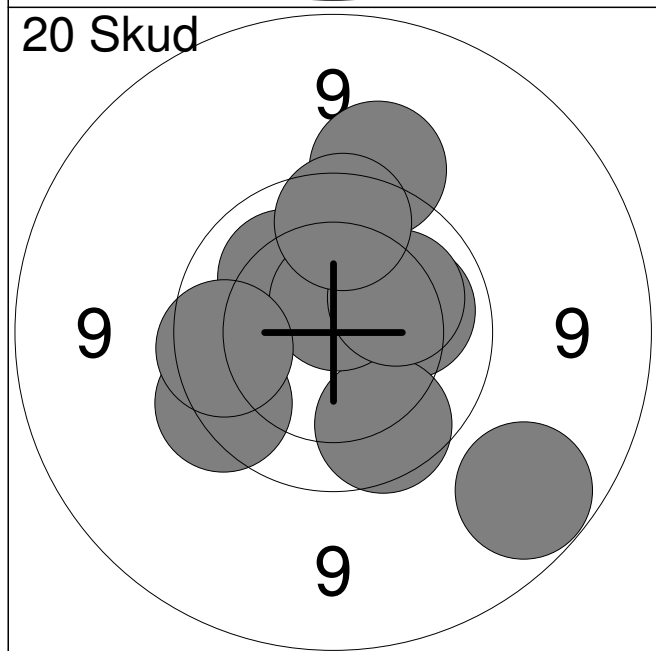

11:	10.1	→
12:	9.0	↘
13:	9.9	↘
14:	10.2	↗
15:	9.5	↑
16:	9.7	↙
17:	10.6x	↑
18:	10.2	↗
19:	9.8	←
20:	9.8	↑
<b>Serie</b>		<b>94</b>
<b>Total</b>		<b>187</b>

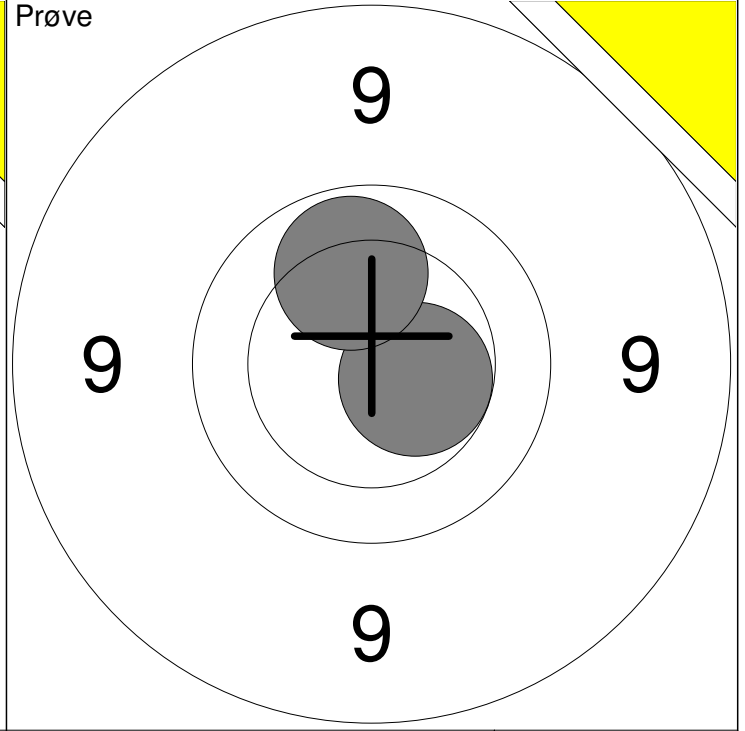
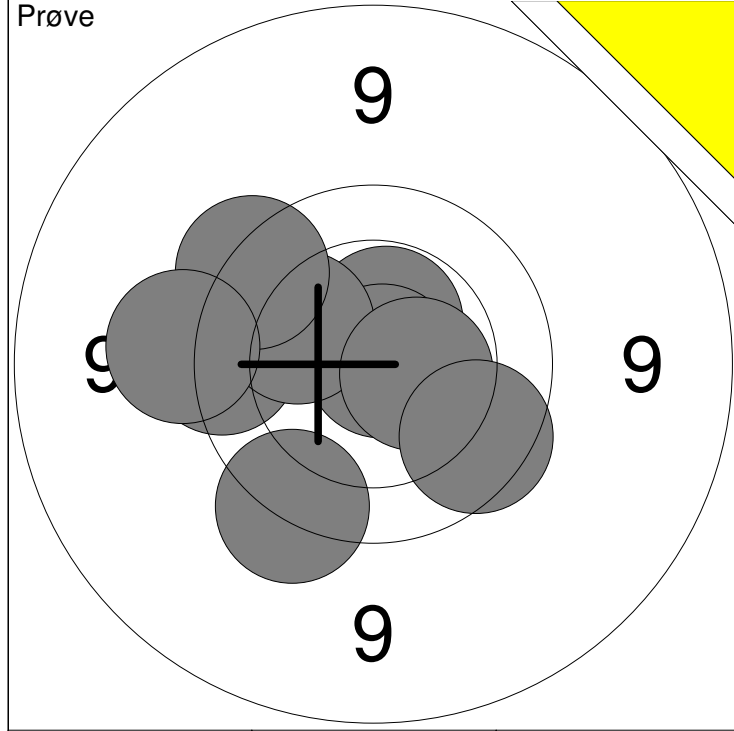

1: 10.5x ↗	6: 10.1 ↖	Serie	94
2: 9.6 ←	7: 9.7 ↗		
3: 9.6 ↘	8: 9.5 ←	Total	0
4: 9.7 ←	9: 10.5x →		
5: 10.9x →	10: 9.8 ↘		

11: 10.5x →	Serie	20
12: 10.0 ↗		
Total		0

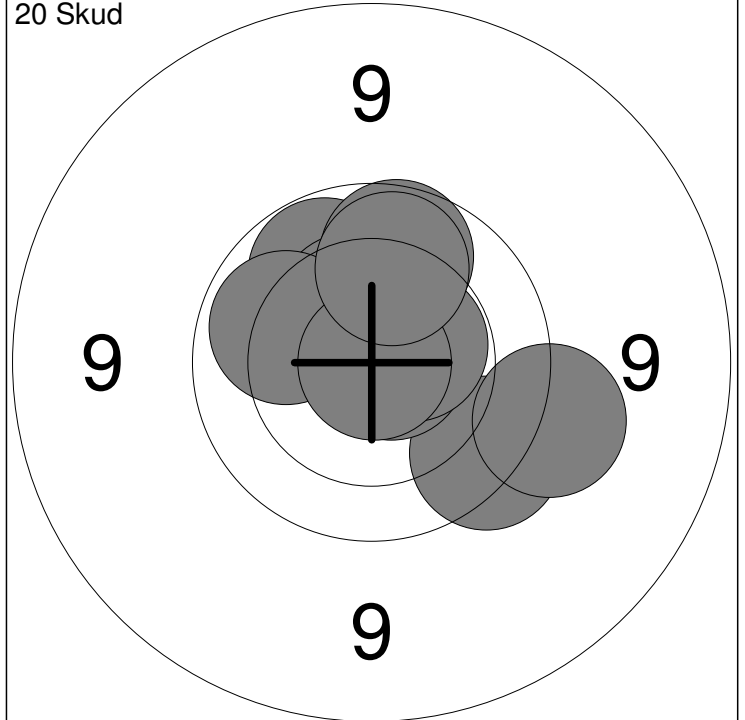
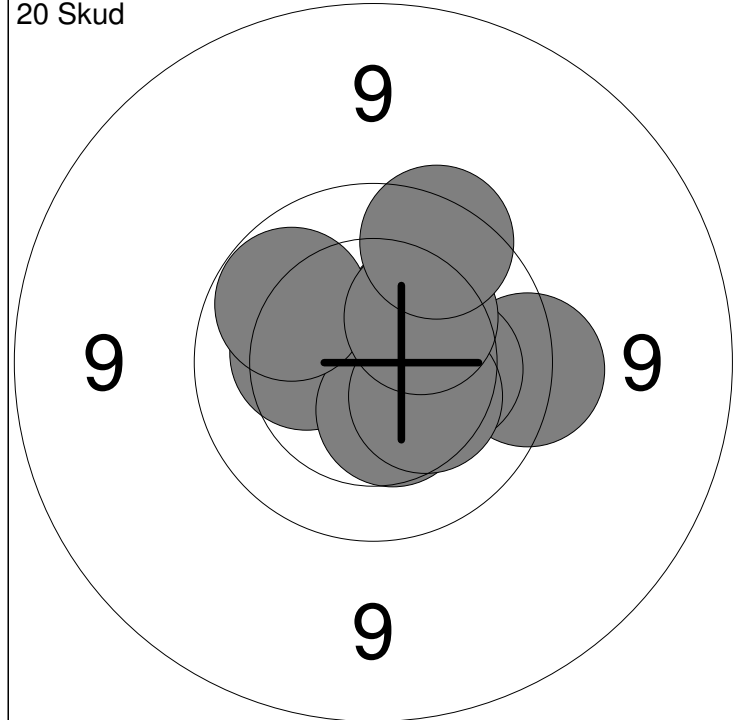

1: 9.7 →	6: 10.2 →	Serie	98
2: 10.4 ↘	7: 10.3 ↘		
3: 10.3 ↗	8: 10.0 ↖	Total	98
4: 10.3 ←	9: 10.3 ↗		
5: 10.4 ↘	10: 9.8 ↗		

11: 9.7 ↘	16: 10.8x →	Serie	97
12: 10.0 ↗	17: 10.5x ↗		
13: 10.4 ↗	18: 9.9 ↗	Total	195
14: 10.0 ↖	19: 10.9x →		
15: 9.5 →	20: 10.0 ↗		



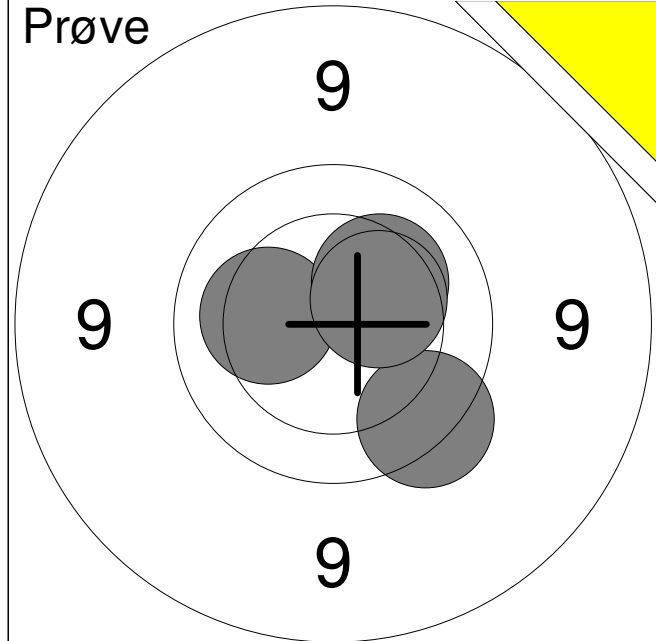

1:	9.7	↘
2:	10.2	←
3:	10.3	↗
4:	10.4	↗
<b>Serie</b>		<b>39</b>
<b>Total</b>		<b>0</b>

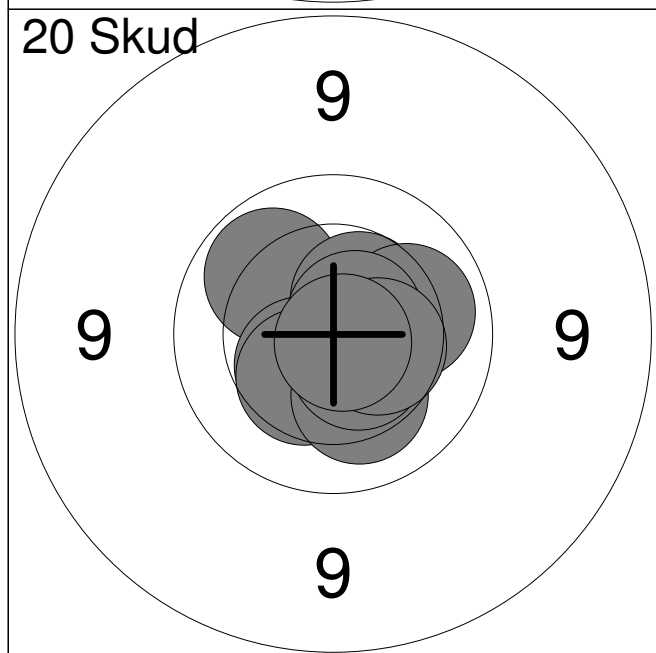

1:	10.0	↗
2:	10.5	↘
3:	10.4	↘
4:	10.5	↗
5:	10.2	↘
6:	10.1	→
7:	10.5x	↘
8:	10.7x	↗
9:	10.4	→
10:	10.8x	↘
<b>Serie</b>		<b>100</b>
<b>Total</b>		<b>100</b>

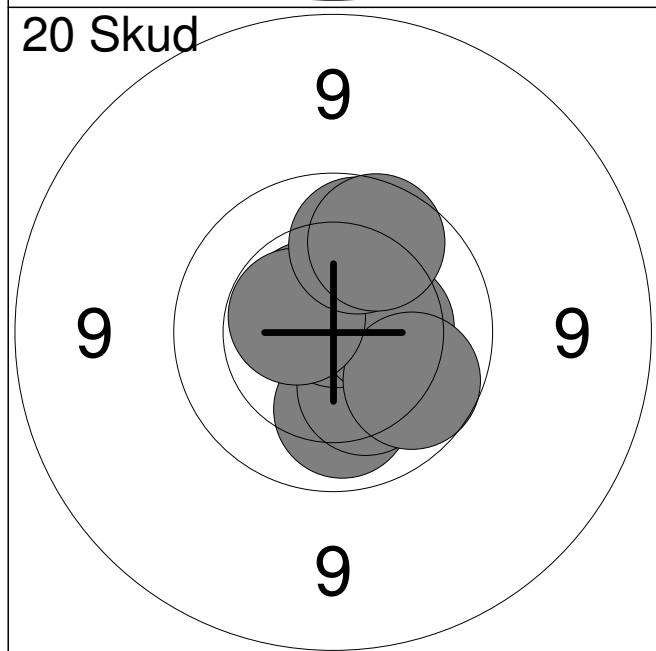

11:	10.6x	↗
12:	10.1	↘
13:	10.2	↘
14:	10.5x	→
15:	10.8x	↗
16:	10.4	→
17:	9.9	↘
18:	10.5x	←
19:	10.0	↗
20:	9.9	↗
<b>Serie</b>		<b>98</b>
<b>Total</b>		<b>198</b>

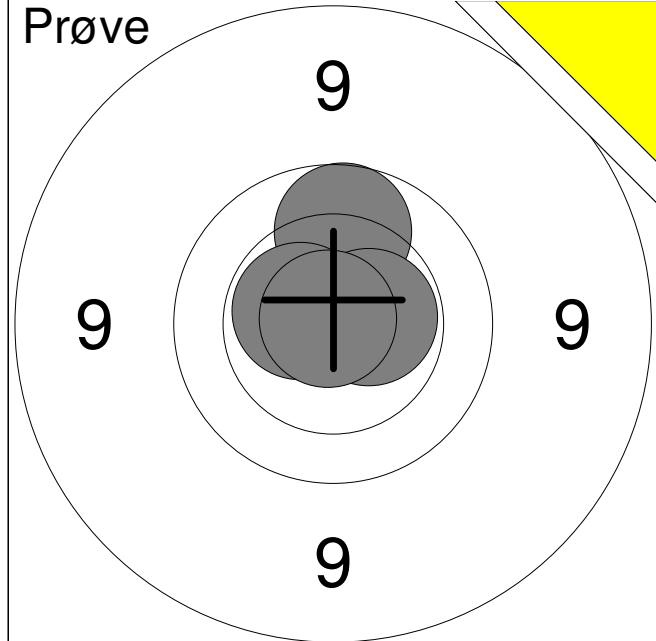

1:	9.9	↑
2:	10.6x	→
3:	10.6x	←
4:	10.9x	↗
<b>Serie</b>		<b>39</b>
<b>Total</b>		<b>0</b>

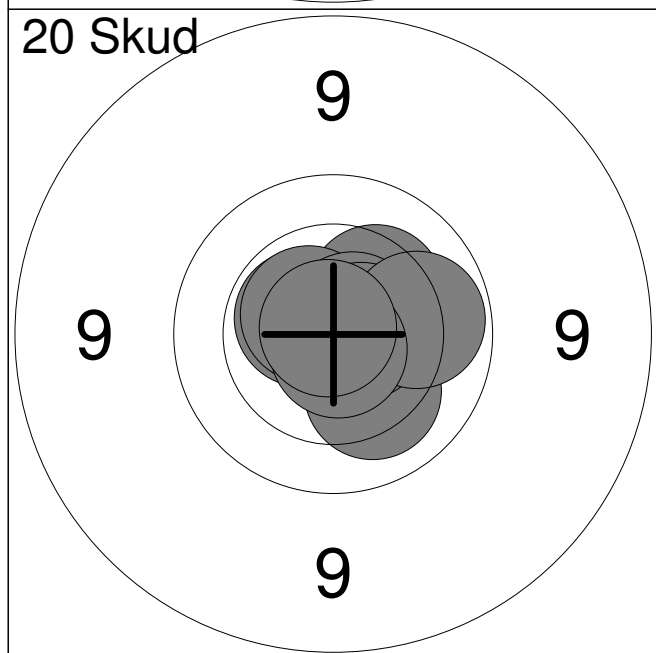

1:	10.3	↗
2:	10.6x	←
3:	10.6x	↘
4:	10.2	↘
5:	10.6x	↗
6:	10.7x	↗
7:	10.6x	→
8:	10.0	→
9:	10.8x	↘
10:	10.9x	↗
<b>Serie</b>		<b>100</b>
<b>Total</b>		<b>100</b>

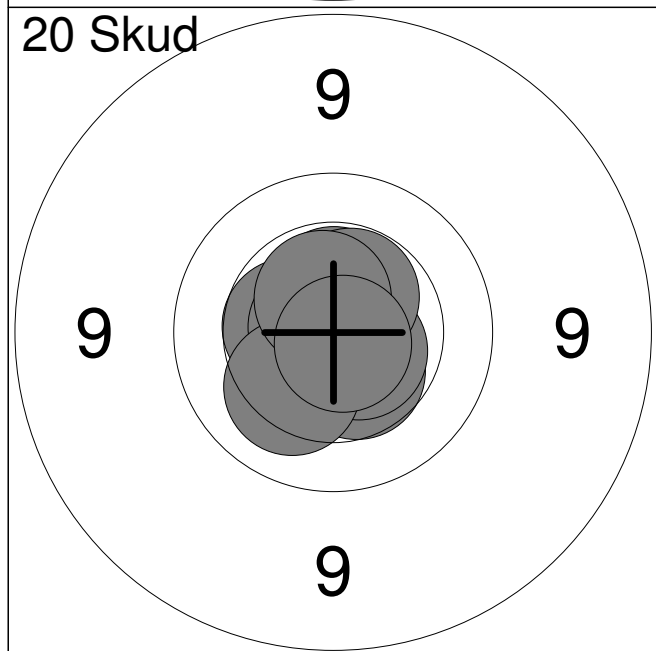

11:	10.5	←
12:	10.8x	←
13:	10.5	↘
14:	10.8x	→
15:	10.6x	↘
16:	10.5x	↑
17:	10.5x	↗
18:	10.2	↘
19:	10.6x	↑
20:	10.8x	↘
<b>Serie</b>		<b>100</b>
<b>Total</b>		<b>200</b>

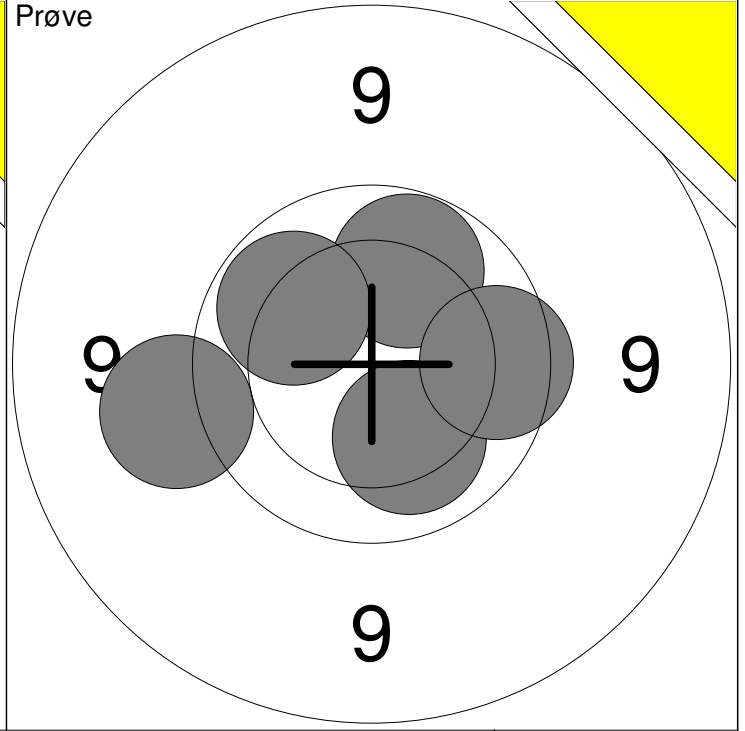
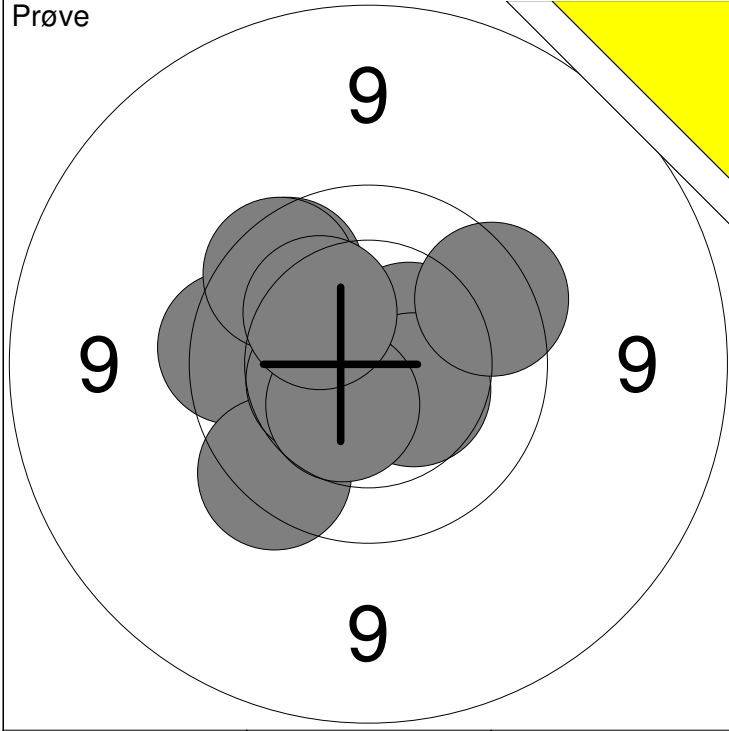

1: 9.8 ↖	6: 10.5 ←	Serie 95
2: 10.5 ↗	7: 9.8 ↖	
3: 10.4 ↘	8: 9.7 ↗	Total 0
4: 9.8 ←	9: 10.5 ↘	
5: 9.7 ↙	10: 10.3 ↖	

11: 10.1 ↘	Serie 48
12: 10.0 ↗	
13: 9.4 ←	Total 0
14: 10.0 ↖	
15: 9.8 →	

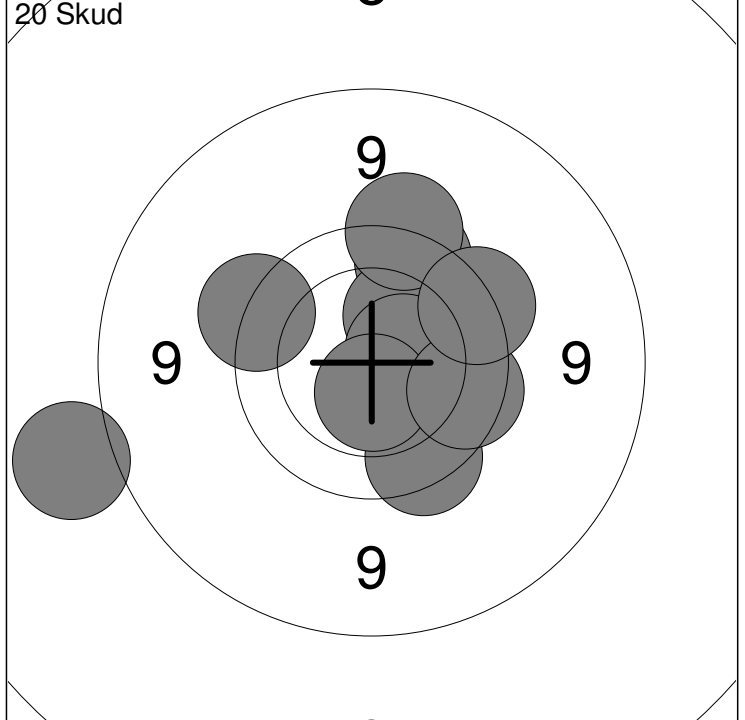
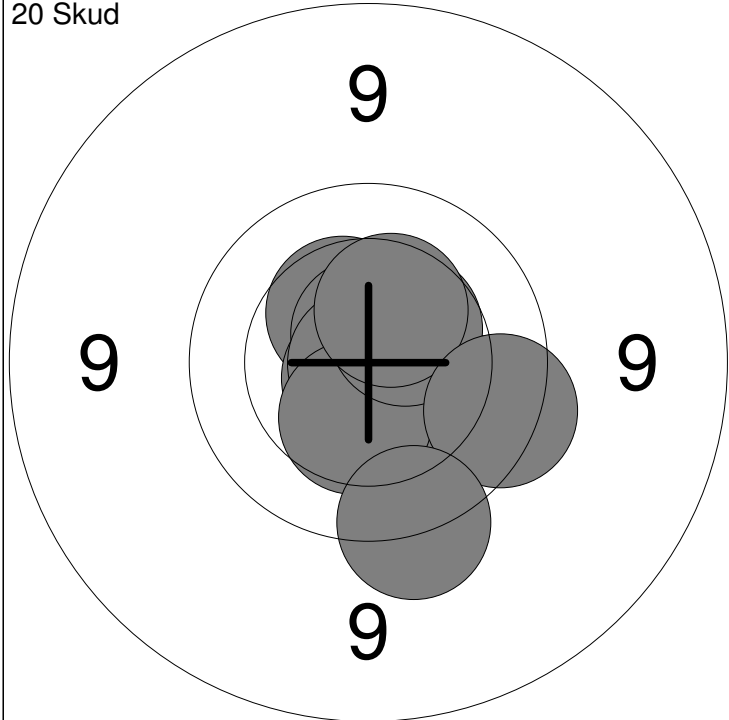

1: 10.4 ↖	6: 10.4 ↘	Serie 98
2: 10.8x ↘	7: 10.5 ↗	
3: 10.7x ↑	8: 10.4 ↗	Total 98
4: 10.1 ↘	9: 9.7 →	
5: 10.9x ←	10: 9.6 ↘	

11: 9.6 ←	16: 10.5x →	Serie 92
12: 9.7 ↘	17: 10.6x ↘	
13: 9.7 ↗	18: 9.8 →	Total 190
14: 8.5 ←	19: 9.5 ↑	
15: 10.2 ↗	20: 9.6 ↗	

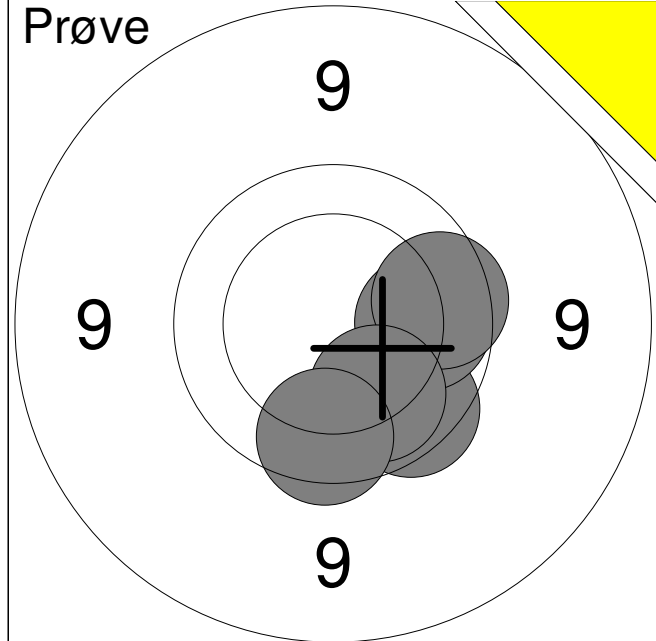

1:	9.8	↘
2:	10.0	→
3:	9.8	→
4:	10.0	↘
5:	9.8	↓
<b>Serie</b>		<b>47</b>
<b>Total</b>		<b>0</b>

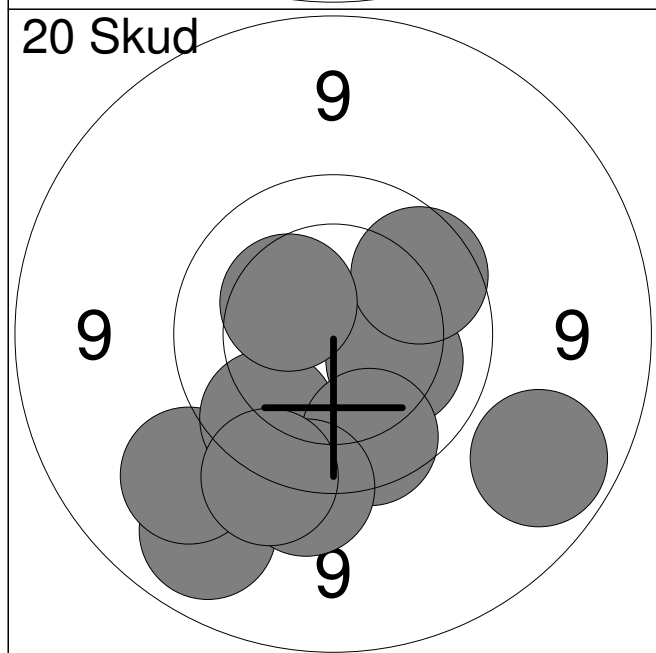

1:	9.1	↘
2:	10.2	→
3:	9.3	↙
4:	9.0	↘
5:	9.9	↘
6:	9.8	↘
7:	9.5	↘
8:	9.9	↗
9:	10.3	↗
10:	9.5	↘
<b>Serie</b>		<b>92</b>
<b>Total</b>		<b>92</b>

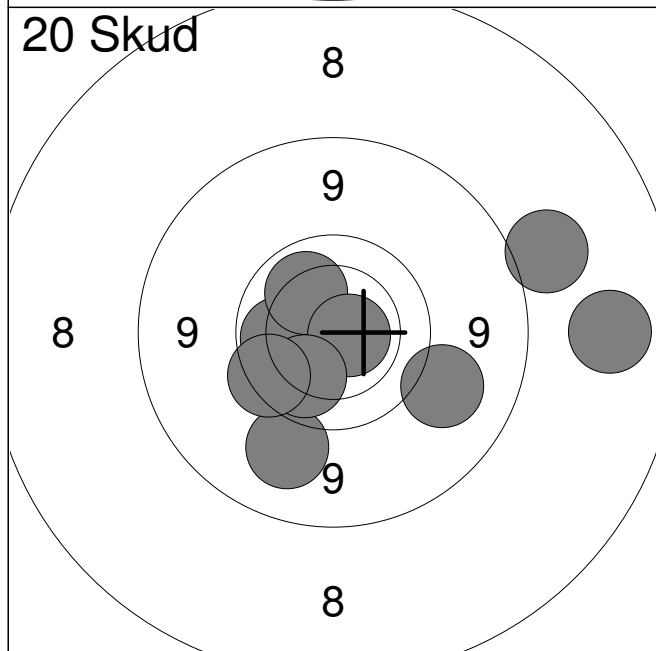

11:	10.4	↗
12:	10.0	←
13:	10.1	↗
14:	10.7x	→
15:	9.3	↘
16:	8.1	→
17:	9.3	↘
18:	8.4	→
19:	10.0	↘
20:	9.7	↙
<b>Serie</b>		<b>93</b>
<b>Total</b>		<b>185</b>

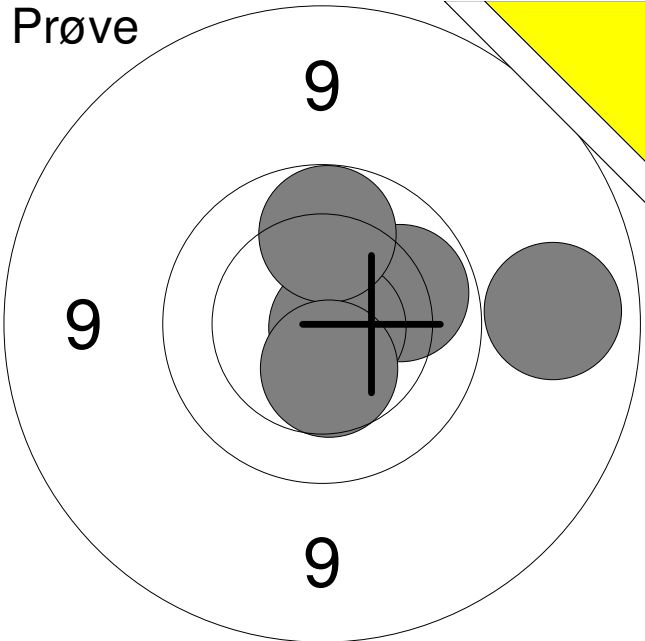
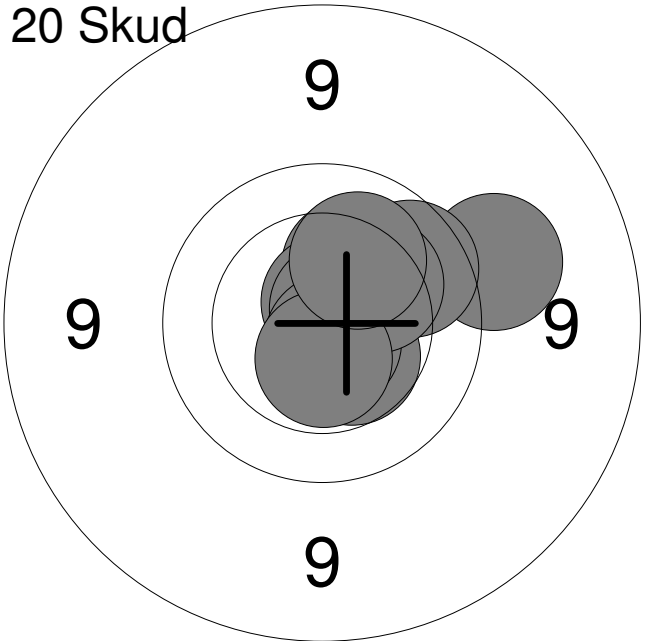
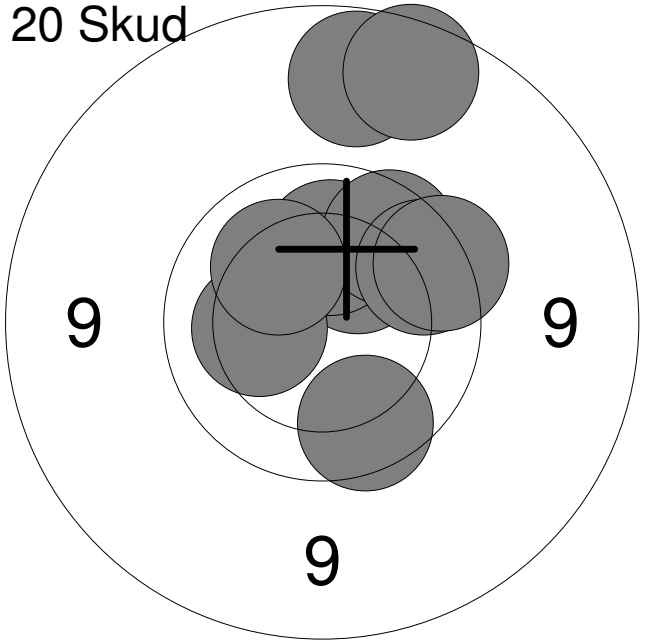
Hold	Skive	Annika Andersen	
54	9	Aalborg	Frederikshavn Skyttekreds
		UÅ2	
		Nordjysk mesterskab 2018	Aalborg Skyttekreds
Prøve		1: 10.0	→
		2: 10.8x	→
		3: 10.0	↑
		4: 10.5	↓
		5: 9.1	→
		Serie	49
		Total	0
20 Skud		1: 9.4	→
		2: 10.3	↑
		3: 10.5	↓
		4: 10.7x	↑
		5: 9.9	→
		6: 10.7x	→
		7: 10.7x	↓
		8: 10.2	→
		9: 10.6x	↓
		10: 10.2	↑
		Serie	98
		Total	98
20 Skud		11: 10.2	↑
		12: 10.1	↑
		13: 9.8	↓
		14: 9.8	↑
		15: 9.8	→
		16: 9.7	→
		17: 10.3	←
		18: 9.0	↑
		19: 10.2	↖
		20: 8.9	↑
		Serie	93
		Total	191

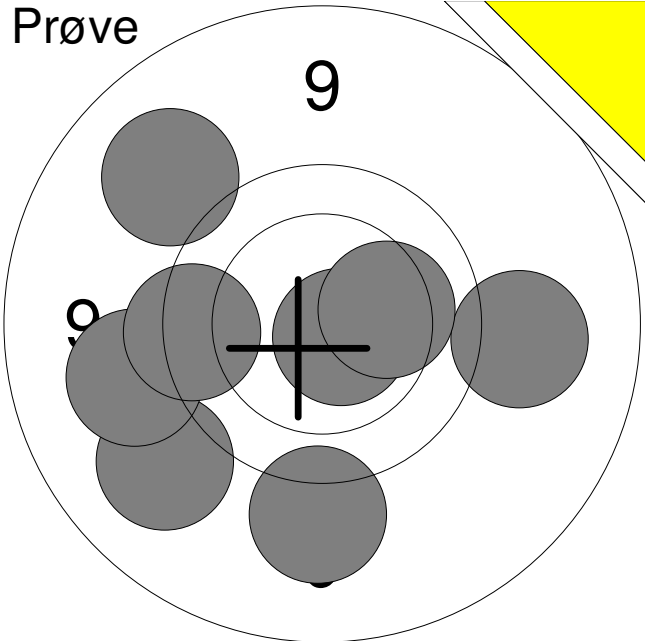
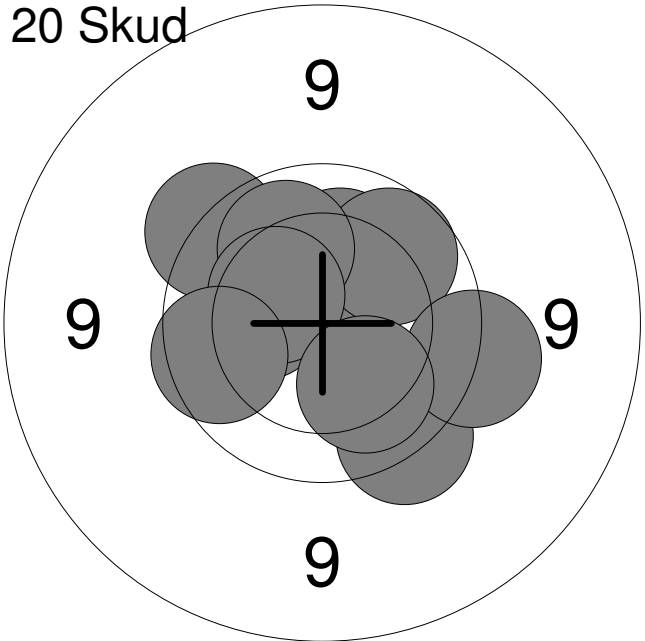
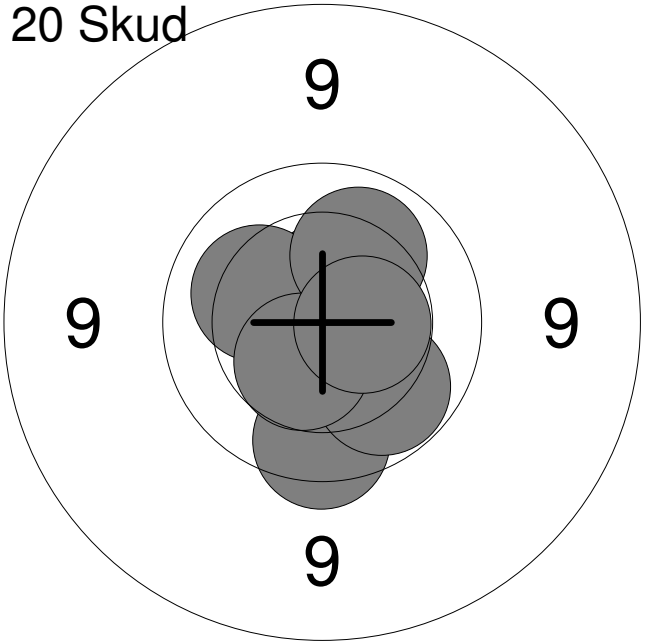
Hold <b>54</b>	Skive <b>10</b>	<b>Pernille Holst Andersen</b>		
Aalborg		Skytteforening Kimbrene		US1
		Nordjysk mesterskab 2018	Aalborg Skyttekreds	
<b>Prøve</b> 		1: 9.3	→	
		2: 9.2	↙	
		3: 9.3	↓	
		4: 10.7x	↘	
		5: 9.3	←	
		6: 9.7	←	
		7: 9.2	↗	
		8: 10.2	→	
		<b>Serie</b>	<b>74</b>	
		<b>Total</b>	<b>0</b>	
<b>20 Skud</b> 		1: 10.3	←	
		2: 9.6	↗	
		3: 10.2	↑	
		4: 9.9	↗	
		5: 10.0	↗	
		6: 10.4	↗	
		7: 9.6	↘	
		8: 9.5	→	
		9: 9.8	←	
		10: 10.1	↘	
		<b>Serie</b>	<b>95</b>	
		<b>Total</b>	<b>95</b>	
<b>20 Skud</b> 		11: 9.8	↓	
		12: 10.7x	↓	
		13: 10.9x	↗	
		14: 10.0	↘	
		15: 10.6x	↑	
		16: 10.7x	↗	
		17: 10.2	←	
		18: 10.1	↗	
		19: 10.5	↘	
		20: 10.5x	→	
		<b>Serie</b>	<b>99</b>	
		<b>Total</b>	<b>194</b>	

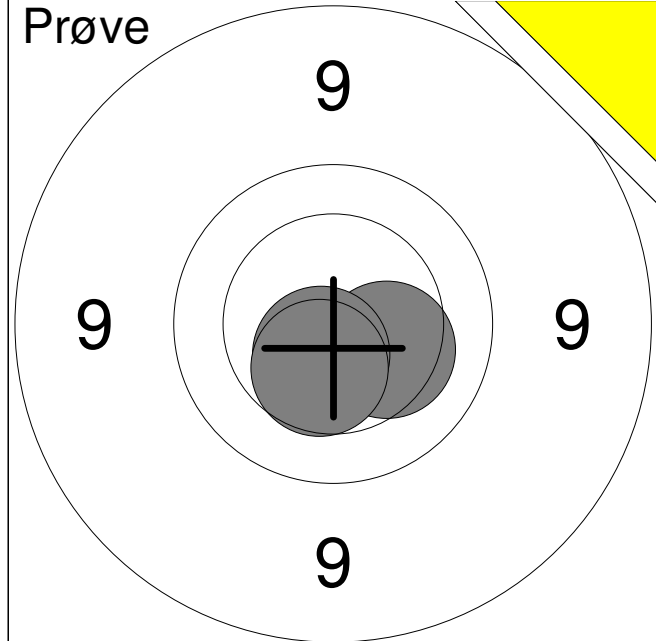

1:	10.3	→
2:	10.6x	↓
3:	10.4	↓
<b>Serie</b>		<b>30</b>
<b>Total</b>		<b>0</b>

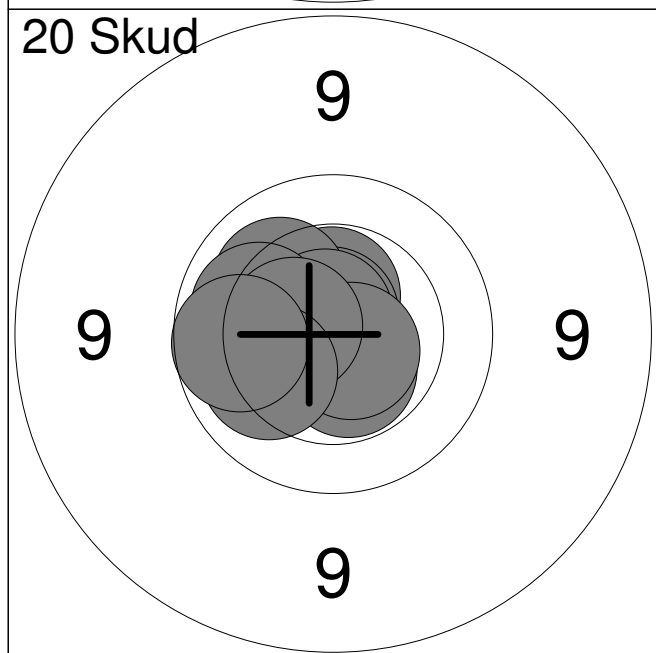

1:	10.5x	↑
2:	10.7x	↑
3:	10.2	↗
4:	10.5x	↓
5:	10.7x	↗
6:	10.1	←
7:	10.7x	↓
8:	10.5x	←
9:	10.1	↙
10:	9.9	←
<b>Serie</b>		<b>99</b>
<b>Total</b>		<b>99</b>

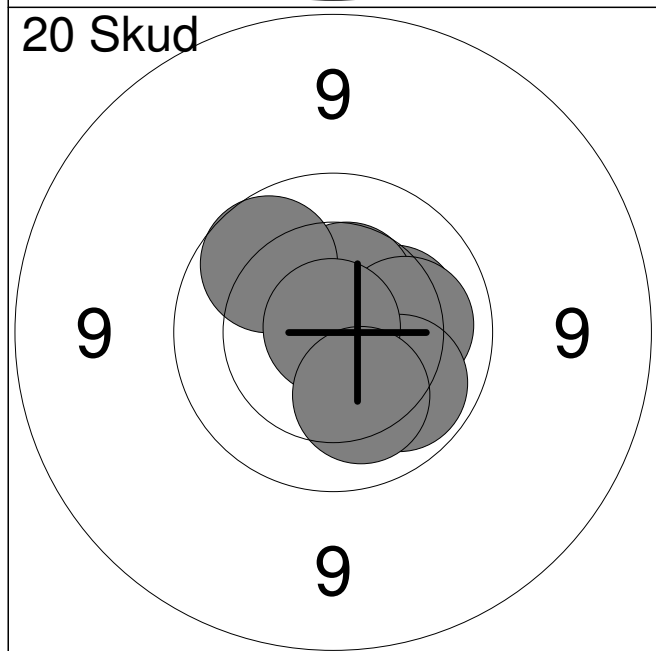

11:	10.9x	→
12:	10.3	→
13:	10.6x	↗
14:	10.2	↓
15:	10.5	↑
16:	10.2	→
17:	9.9	↗
18:	10.0	↓
19:	10.9x	↗
20:	10.2	↓
<b>Serie</b>		<b>99</b>
<b>Total</b>		<b>198</b>

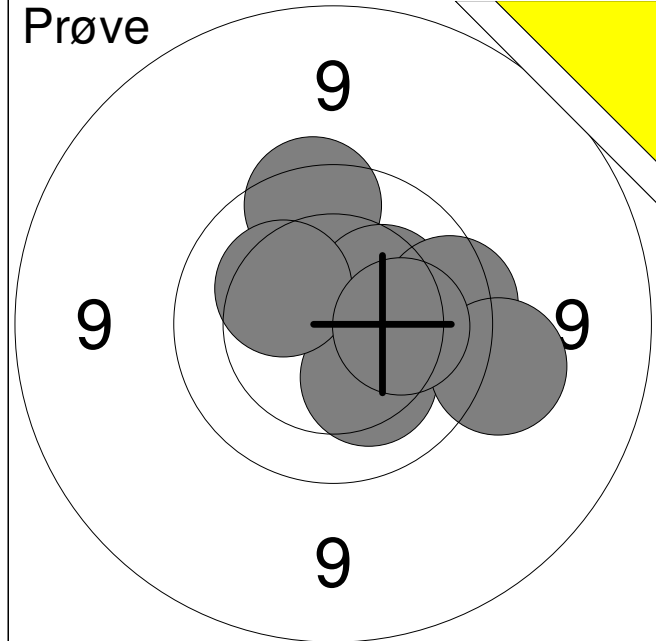

1:	9.8	↑
2:	10.4	→
3:	10.3	↗
4:	10.2	↘
5:	9.8	→
6:	9.5	→
7:	10.3	↗
8:	10.2	→
<b>Serie</b>		<b>77</b>
<b>Total</b>		<b>0</b>

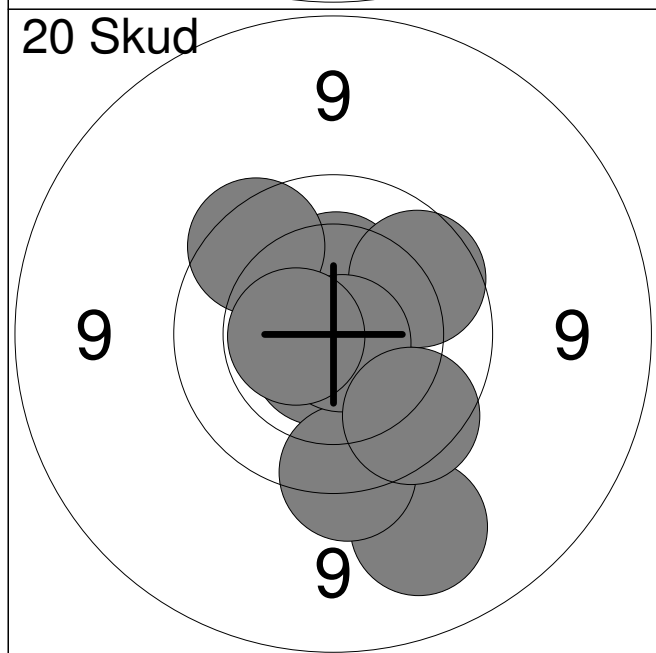

1:	10.5x	↗
2:	10.4	↑
3:	10.7x	↘
4:	9.9	↗
5:	9.2	↘
6:	9.8	↗
7:	9.6	↘
8:	10.8x	↘
9:	9.8	↘
10:	10.5x	←
<b>Serie</b>		<b>95</b>
<b>Total</b>		<b>95</b>

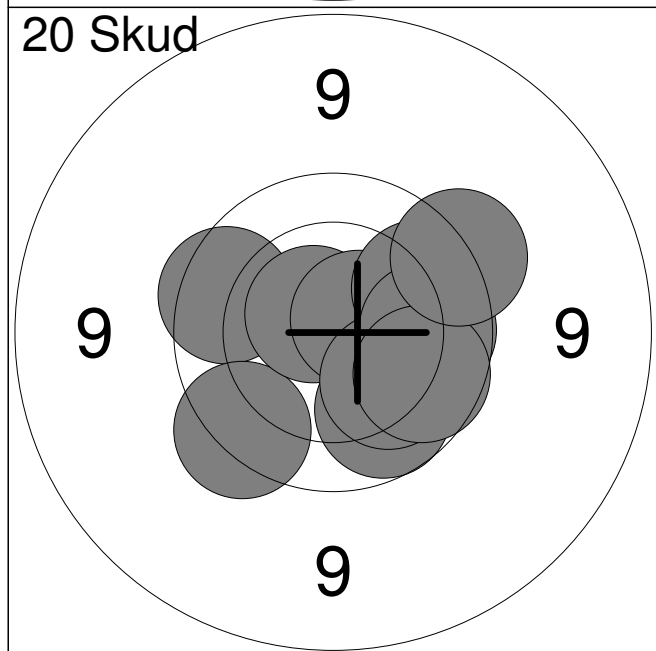

11:	9.8	↖
12:	9.7	↘
13:	9.9	↘
14:	10.7x	↗
15:	10.6x	↗
16:	10.1	↘
17:	9.9	↗
18:	9.9	→
19:	9.9	↘
20:	9.6	↗
<b>Serie</b>		<b>93</b>
<b>Total</b>		<b>188</b>



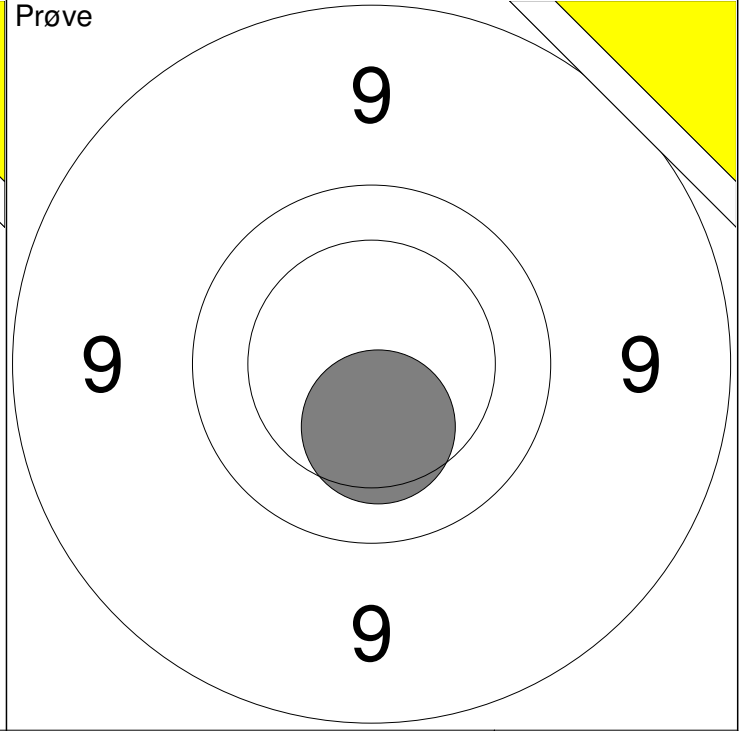
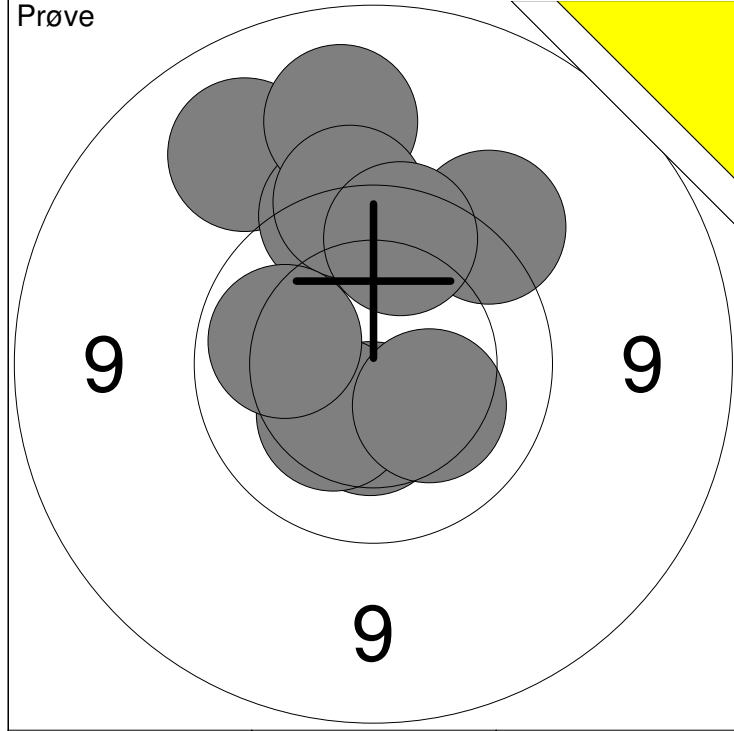

1: 9.1 ↖	6: 9.8 ↑	Serie 94
2: 9.7 ↑	7: 10.4 ↓	
3: 9.2 ↑	8: 10.3 ↙	Total 0
4: 9.6 ↑	9: 10.1 ←	
5: 9.5 ↗	10: 10.3 ↘	

11: 10.3 ↓	Serie 10
	Total 0

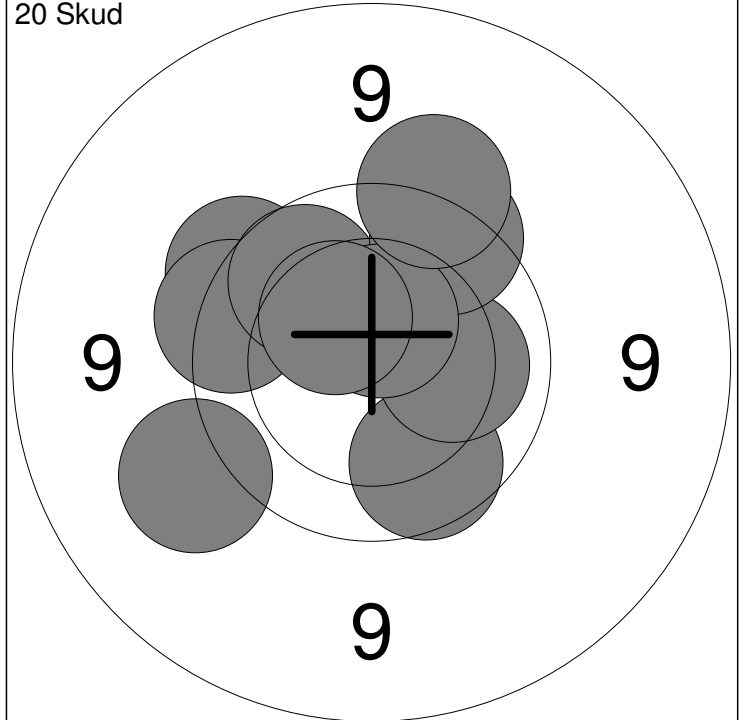
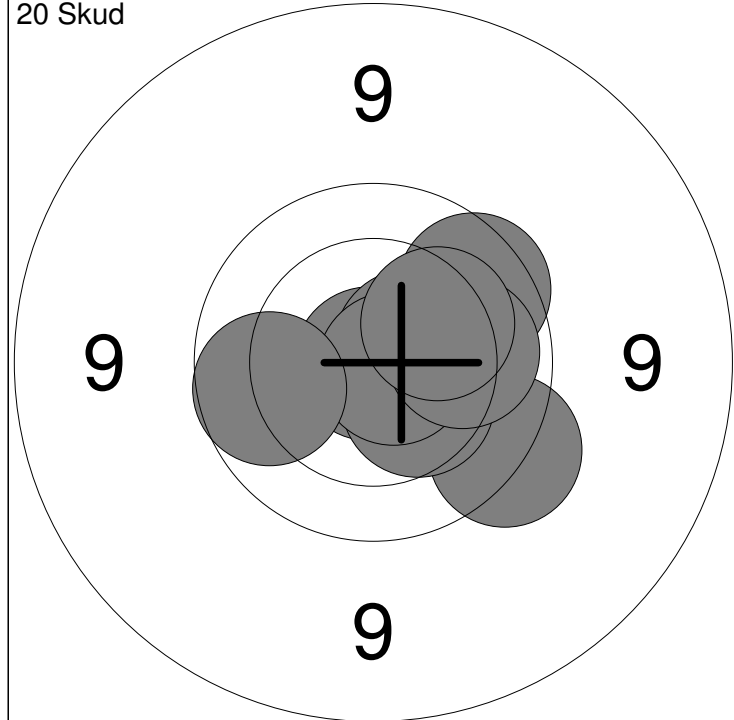

1: 9.8 ↗	6: 10.4 ↘	Serie 97
2: 10.4 →	7: 10.7x →	
3: 9.6 ↘	8: 10.1 →	Total 97
4: 10.9x ←	9: 10.2 ↗	
5: 10.5x ↗	10: 9.9 ←	

11: 9.9 ↓	16: 9.4 ←	Serie 93
12: 9.6 ↗	17: 9.7 ↗	
13: 10.2 →	18: 10.5x ↑	Total 190
14: 9.7 ↖	19: 10.4 ↖	
15: 9.9 ↗	20: 9.5 ↑	

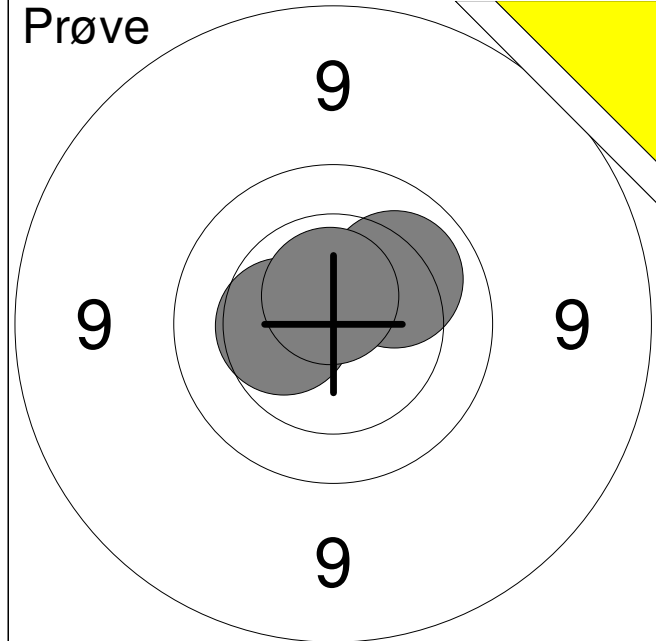

1:	10.4	←
2:	10.1	↗
3:	10.6x	↑
<b>Serie</b>		<b>30</b>
<b>Total</b>		<b>0</b>

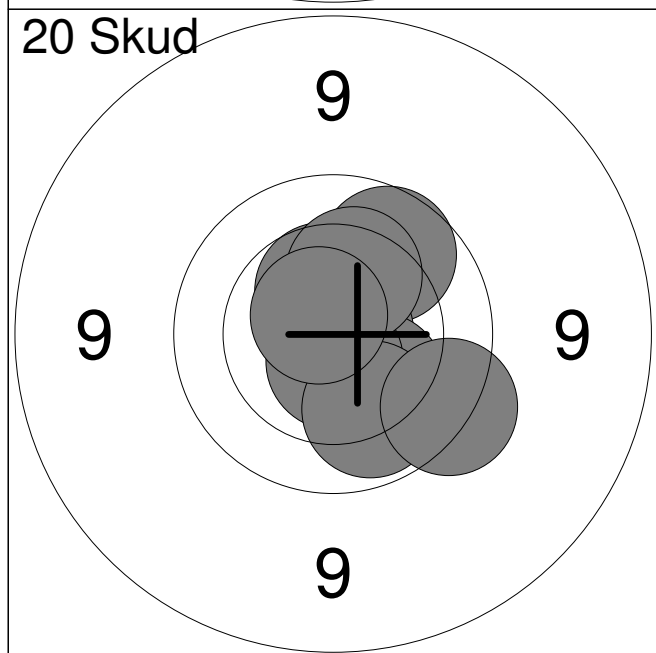

1:	10.8x	↘
2:	9.9	↗
3:	10.5	↑
4:	10.8x	→
5:	10.3	↙
6:	10.6x	↓
7:	10.0	↙
8:	10.3	↑
9:	10.7x	↗
10:	9.7	↘
<b>Serie</b>		<b>98</b>
<b>Total</b>		<b>98</b>

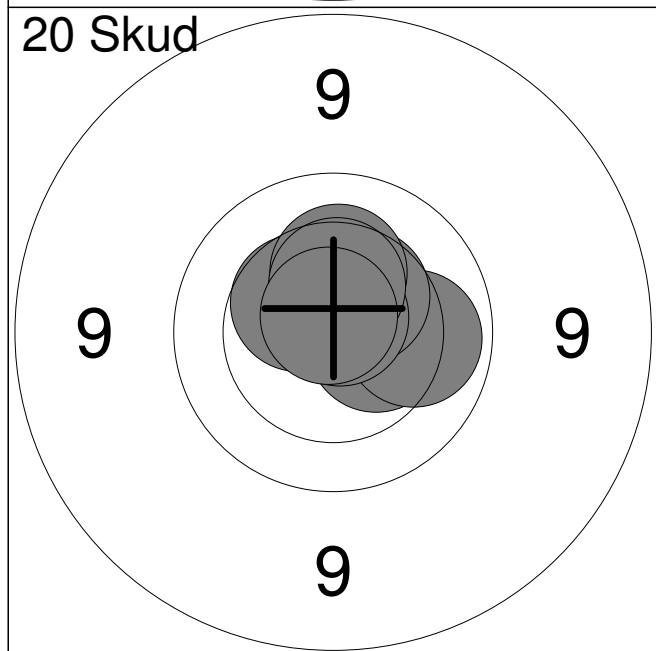

11:	10.5x	↑
12:	10.6x	↗
13:	10.5	→
14:	10.5	↗
15:	10.1	→
16:	10.4	↗
17:	10.3	↑
18:	10.8x	↗
19:	10.4	↑
20:	10.8x	↑
<b>Serie</b>		<b>100</b>
<b>Total</b>		<b>198</b>

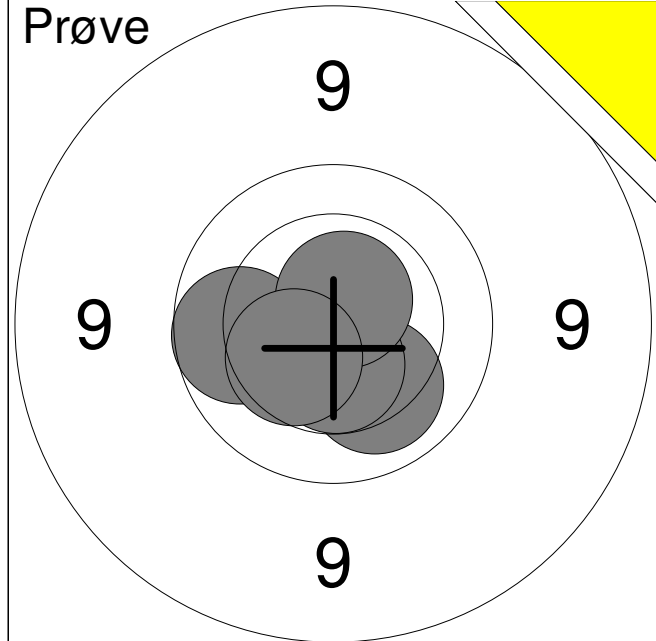

1:	10.1	↘
2:	9.9	←
3:	10.5x	↓
4:	10.7x	↑
5:	10.4	↙
<b>Serie</b>		<b>49</b>
<b>Total</b>		<b>0</b>

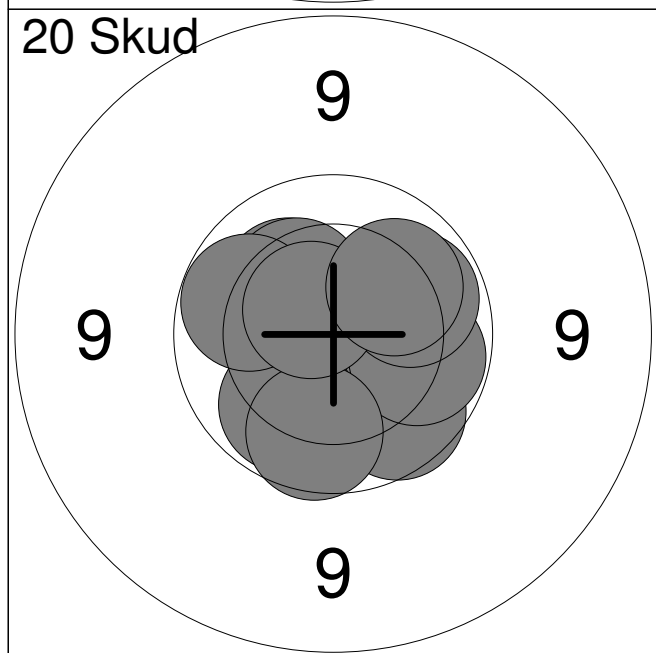

1:	9.9	↘
2:	10.0	→
3:	10.0	↘
4:	9.9	↓
5:	10.0	↗
6:	10.2	↗
7:	10.3	↗
8:	10.0	←
9:	10.6x	↗
10:	10.1	↗
<b>Serie</b>		<b>98</b>
<b>Total</b>		<b>98</b>

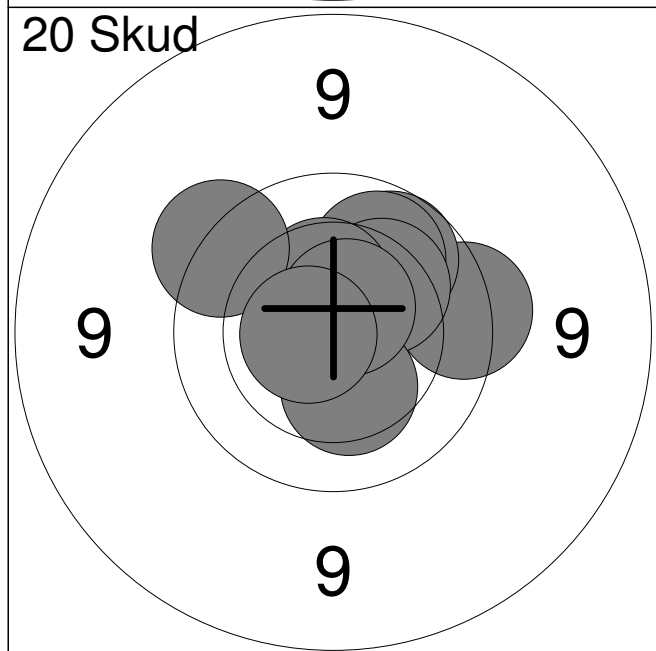

11:	10.6x	↑
12:	9.7	→
13:	9.9	↗
14:	10.0	↗
15:	10.2	↗
16:	10.4	↑
17:	10.3	↓
18:	9.6	↖
19:	10.6x	↗
20:	10.7x	←
<b>Serie</b>		<b>97</b>
<b>Total</b>		<b>195</b>

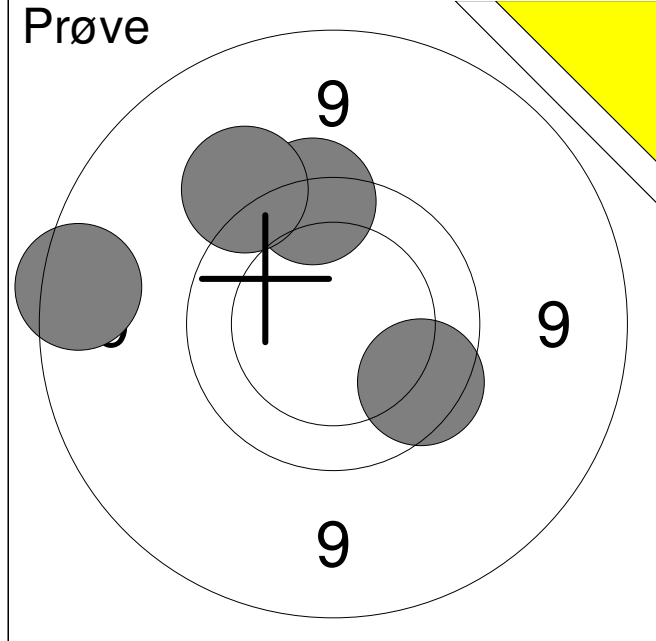

1:	9.8	↘
2:	9.7	↑
3:	9.4	↗
4:	8.8	←
<b>Serie</b>		<b>35</b>
<b>Total</b>		<b>0</b>

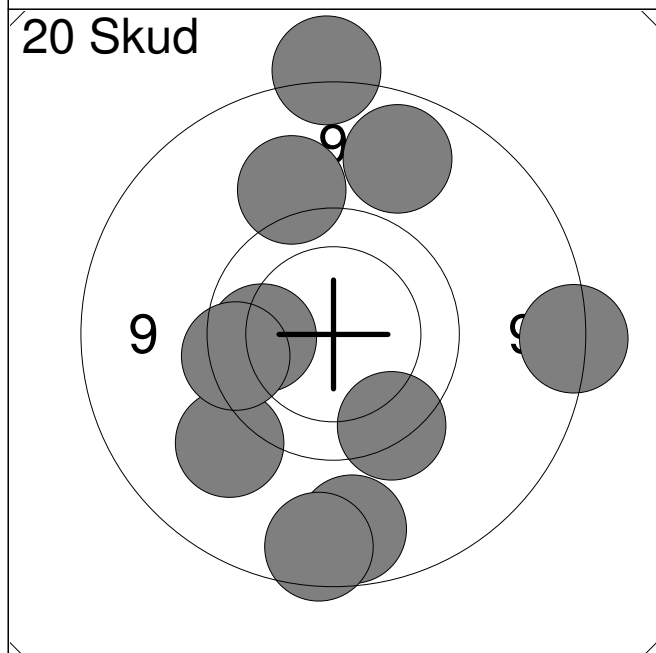

1:	9.0	↓
2:	8.9	↓
3:	9.3	↙
4:	8.7	→
5:	8.6	↑
6:	10.0	←
7:	9.3	↑
8:	9.7	←
9:	9.7	↘
10:	9.0	↑
<b>Serie</b>		<b>88</b>
<b>Total</b>		<b>88</b>

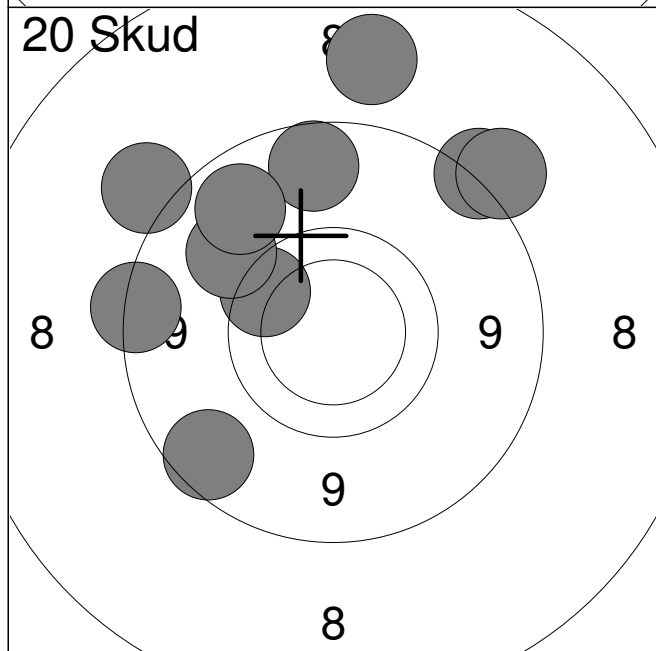

11:	9.8	↖
12:	8.3	↑
13:	8.9	↑
14:	8.7	←
15:	8.6	↗
16:	8.9	↙
17:	9.3	↖
18:	8.5	↗
19:	8.5	↗
20:	9.1	↗
<b>Serie</b>		<b>83</b>
<b>Total</b>		<b>171</b>

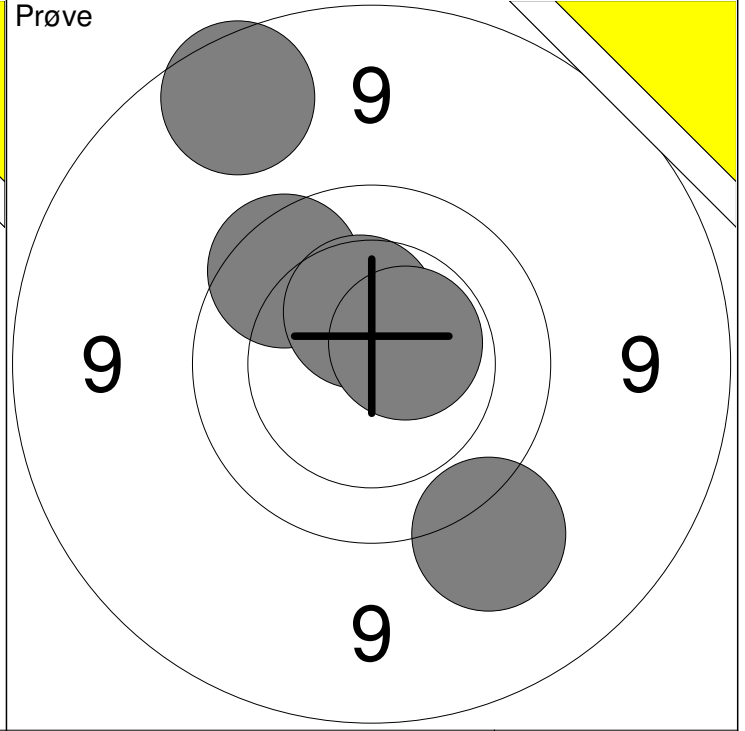
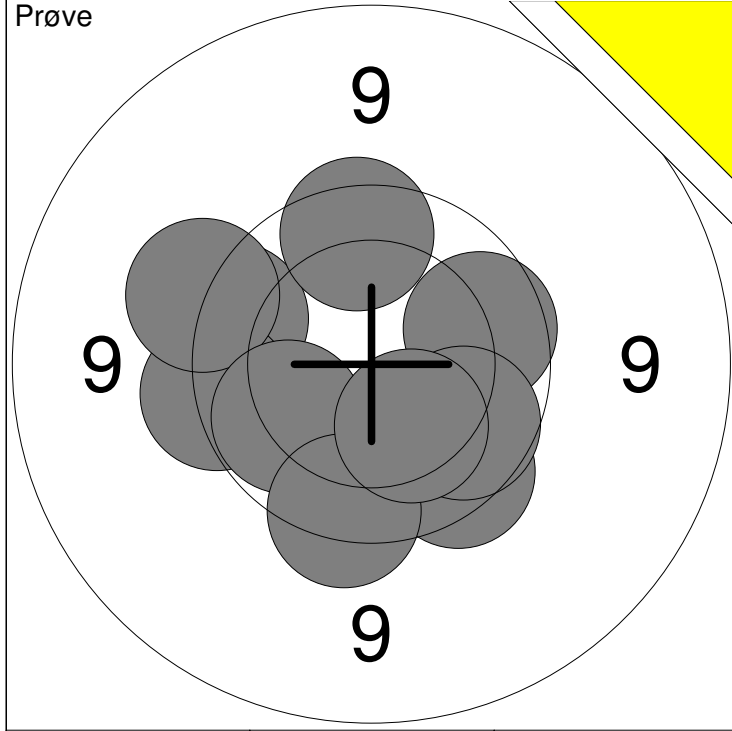

1: 9.9 →	6: 10.0 ←	Serie	92
2: 9.7 ←	7: 9.9 ↘		
3: 9.6 ←	8: 9.7 ↓	Total	0
4: 9.5 ↗	9: 10.2 ↓		
5: 9.7 ↓	10: 9.8 ↑		

11: 9.8 ↗	Serie	46
12: 9.4 ↓		
13: 10.4 ↑	Total	0
14: 8.9 ↗		
15: 10.6x ↗		

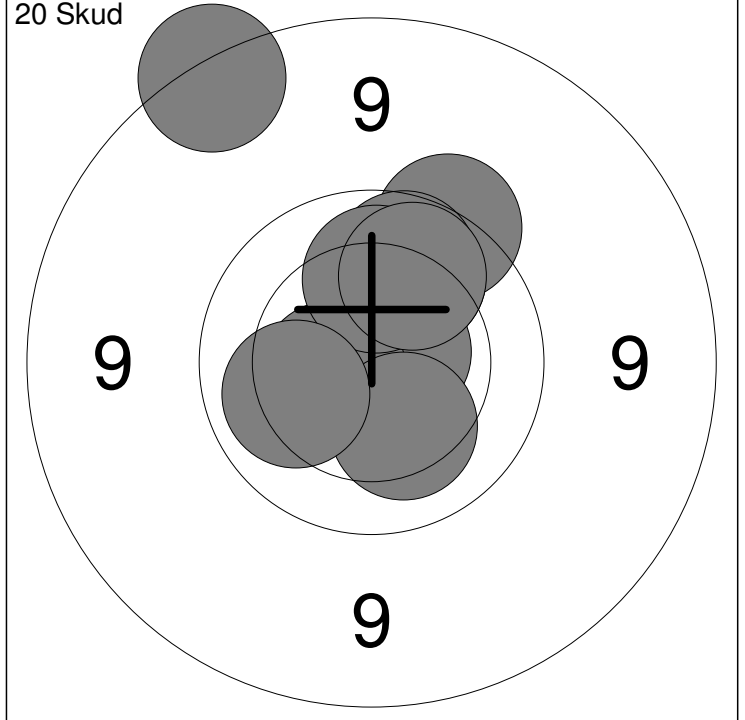
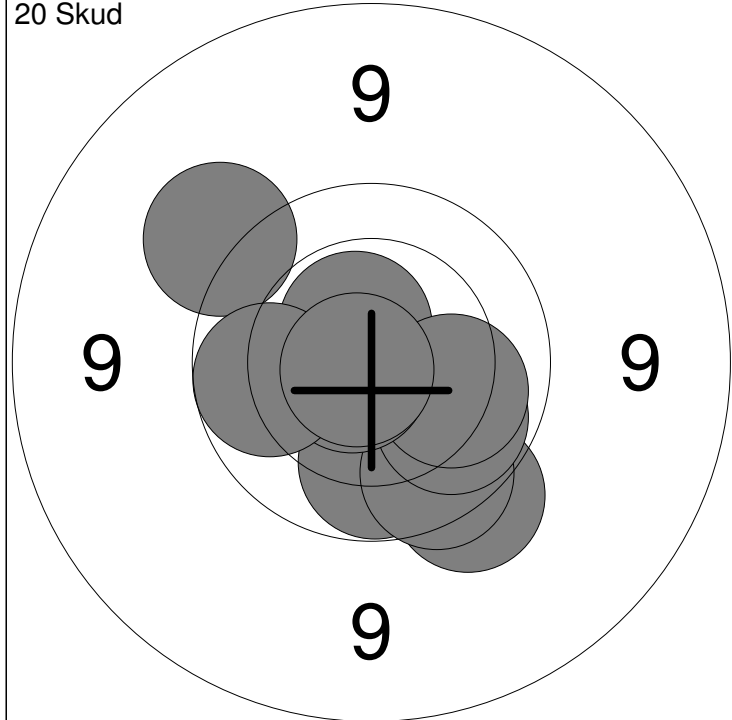

1: 9.6 ↓	6: 10.1 →	Serie	96
2: 10.0 ↓	7: 9.4 ↗		
3: 9.8 ↓	8: 10.7x ←	Total	96
4: 10.0 ↓	9: 9.9 ←		
5: 10.6x ↗	10: 10.8x ←		

11: 10.0 ↗	16: 10.5x ←	Serie	96
12: 8.7 ↗	17: 10.2 ↓		
13: 9.6 ↗	18: 10.1 ↑	Total	192
14: 9.9 ↗	19: 10.1 ←		
15: 10.7x ↗	20: 10.0 ↑		

Hold	Skive	John Andersen		
56	3	Aalborg	Frederikshavn Skyttekreds	MVÅ2
Prøve		Nordjysk mesterskab 2018	Aalborg Skyttekreds	
	1:	10.3	↘	
	2:	10.3	↗	
	3:	9.9	↗	
	4:	10.3	↖	
	5:	10.3	↘	
	Serie			49
Total			0	
	1:	9.3	↘	
	2:	10.5	↗	
	3:	9.7	↘	
	4:	10.5	→	
	5:	10.4	↘	
	6:	10.2	↗	
	7:	10.5	↗	
	8:	10.1	→	
	9:	9.8	↗	
	10:	10.7x	↘	
Serie			97	
Total			97	
	11:	9.8	↘	
	12:	10.0	↗	
	13:	10.4	↘	
	14:	10.9x	↘	
	15:	9.6	↘	
	16:	10.6x	↘	
	17:	10.5	↘	
	18:	10.0	↖	
	19:	9.7	↗	
	20:	9.8	↖	
Serie			96	
Total			193	

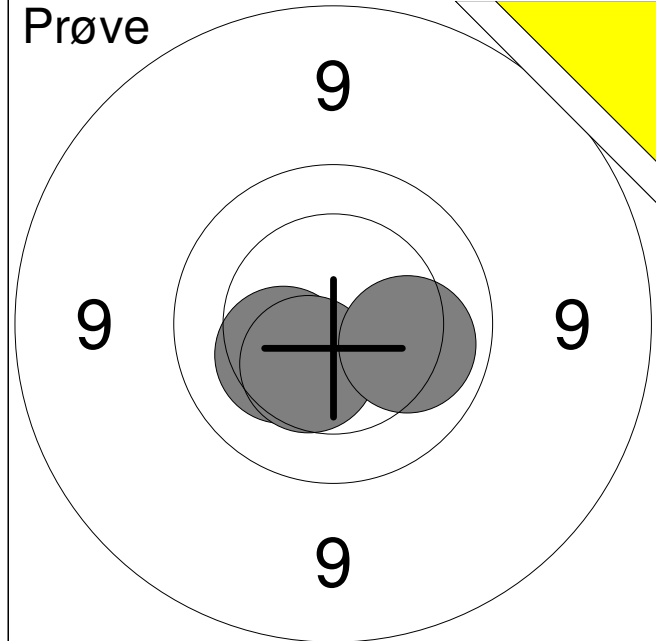

1:	10.3	↙
2:	10.4	↓
3:	10.1	→
<b>Serie</b>		<b>30</b>
<b>Total</b>		<b>0</b>

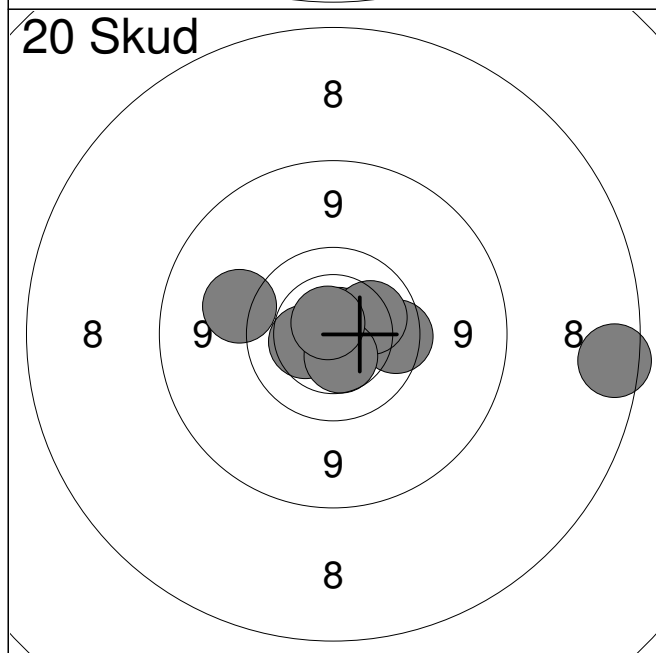

1:	10.5	→
2:	10.7x	↗
3:	10.8x	↓
4:	10.4	←
5:	9.8	→
6:	10.1	↗
7:	10.5	↓
8:	7.9	→
9:	10.7x	↗
10:	9.4	←
<b>Serie</b>		<b>95</b>
<b>Total</b>		<b>95</b>

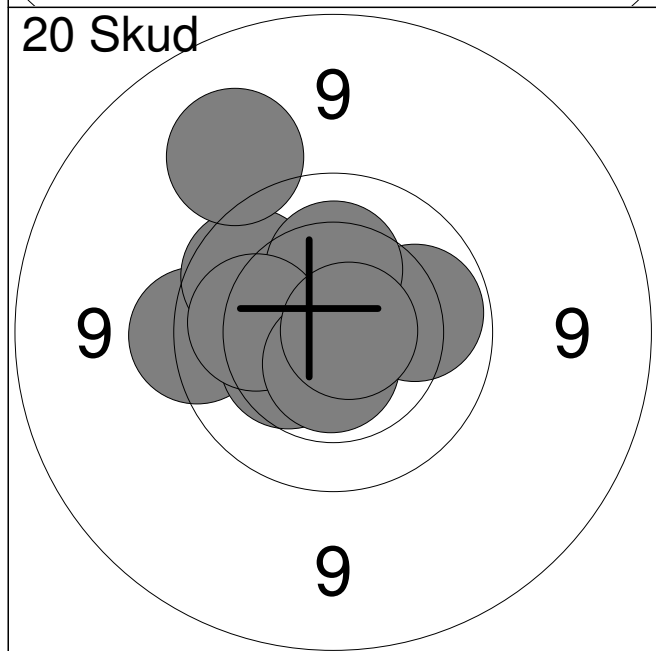

11:	10.6x	←
12:	9.7	←
13:	10.0	→
14:	9.9	↖
15:	10.4	←
16:	10.3	↑
17:	10.1	←
18:	10.6x	↓
19:	10.8x	→
20:	9.3	↗
<b>Serie</b>		<b>97</b>
<b>Total</b>		<b>192</b>

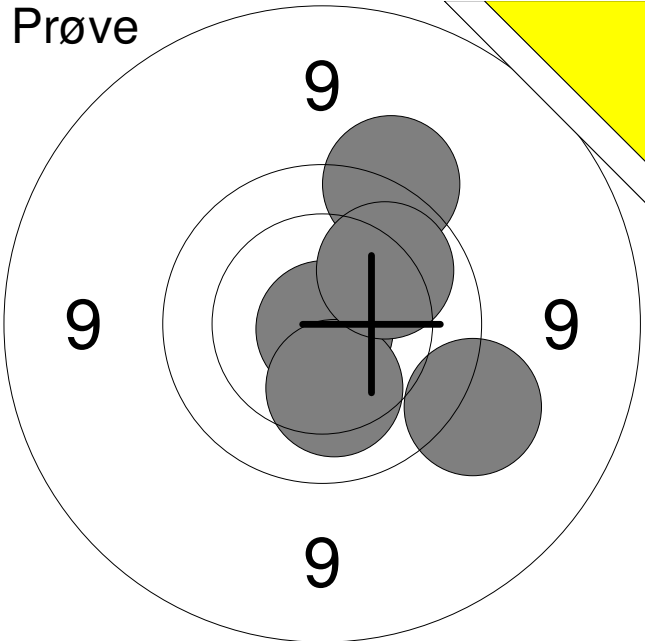
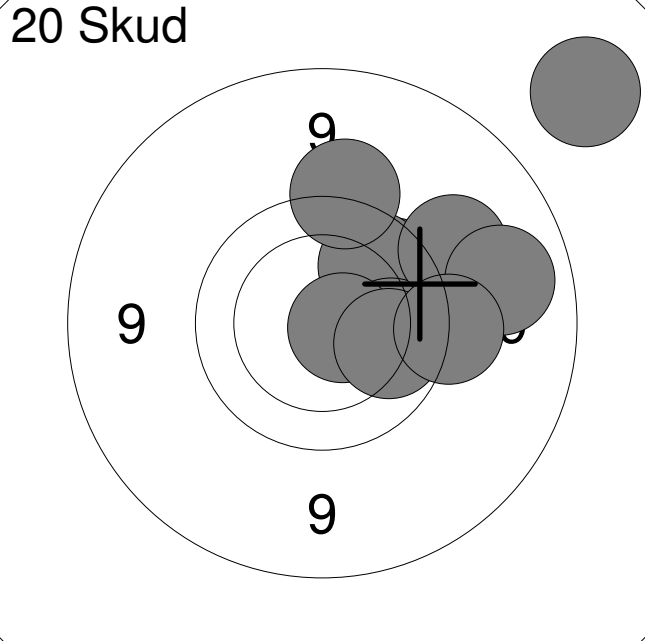
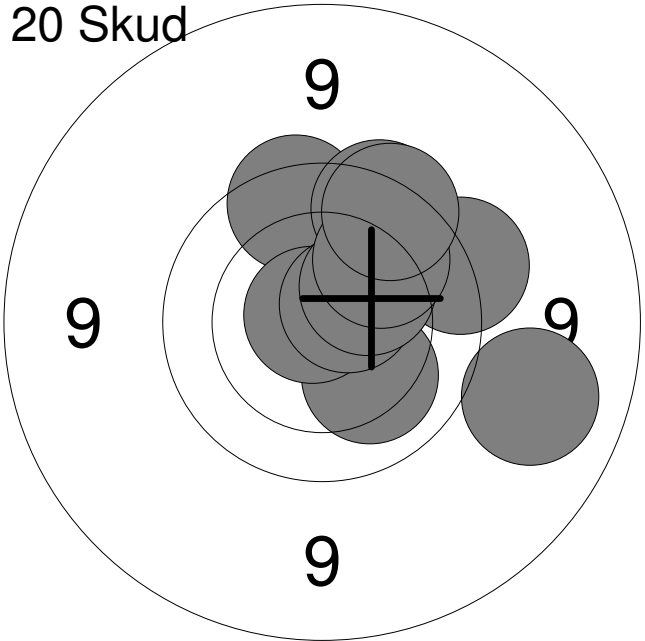
Hold <b>56</b>	Skive <b>9</b>	<b>Annika Andersen</b>		
Aalborg		Frederikshavn Skyttekreds		MUÅ2
		Nordjysk mesterskab 2018	Aalborg Skyttekreds	
<b>Prøve</b> 		1: 9.5	↗	
		2: 9.4	→	
		3: 10.9x	↘	
		4: 10.2	↘	
		5: 10.0	↗	
		<b>Serie</b>	<b>48</b>	
		<b>Total</b>	<b>0</b>	
<b>20 Skud</b> 		1: 8.2	↗	
		2: 9.8	↗	
		3: 9.9	↗	
		4: 10.0	→	
		5: 10.7x	→	
		6: 9.5	↑	
		7: 9.3	↗	
		8: 9.1	→	
		9: 10.0	→	
		10: 9.5	→	
		<b>Serie</b>	<b>92</b>	
		<b>Total</b>	<b>92</b>	
<b>20 Skud</b> 		11: 10.2	↘	
		12: 9.8	↑	
		13: 10.8x	↗	
		14: 10.6x	↗	
		15: 9.6	→	
		16: 9.7	↑	
		17: 9.1	→	
		18: 10.3	↗	
		19: 10.0	↗	
		20: 9.7	↗	
		<b>Serie</b>	<b>95</b>	
		<b>Total</b>	<b>187</b>	



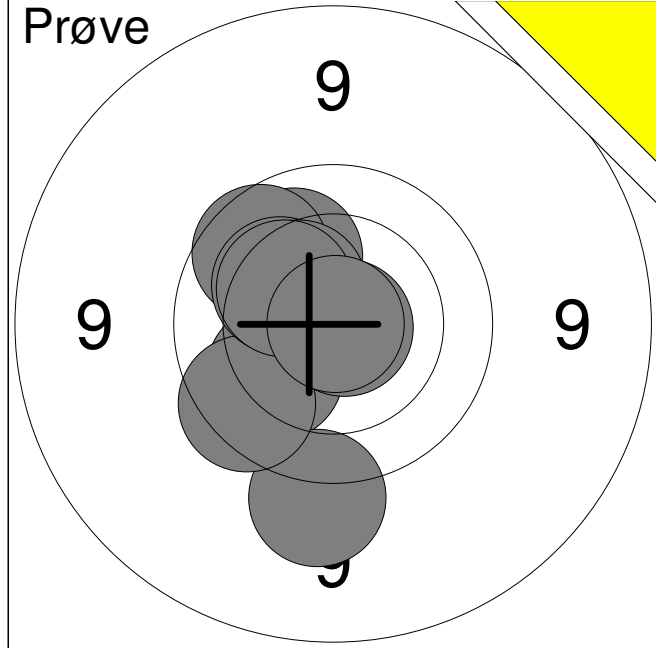

1:	10.1	↙
2:	9.4	↓
3:	9.8	↙
4:	10.1	↗
5:	10.8x	↘
6:	9.9	↗
7:	10.2	↗
8:	10.4	↗
9:	10.3	↗
10:	10.9x	→
<b>Serie</b>		<b>97</b>
<b>Total</b>		<b>0</b>

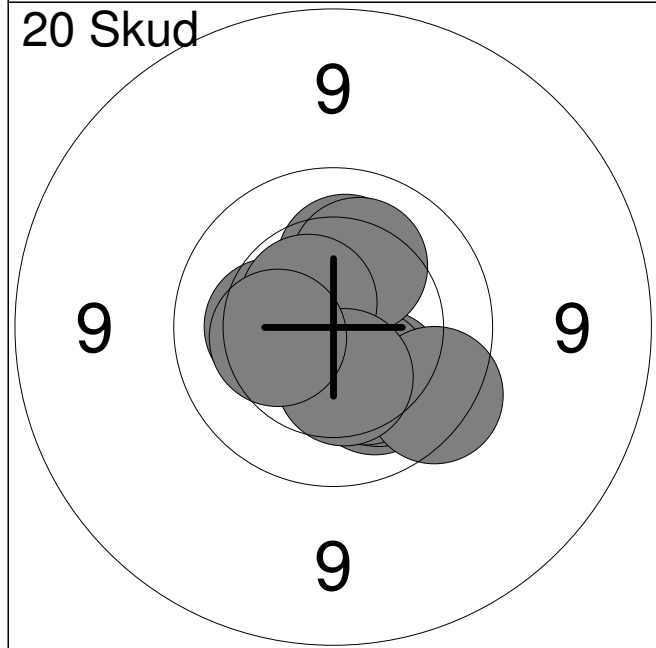

1:	10.2	↙
2:	10.3	←
3:	10.2	↙
4:	10.3	↙
5:	9.8	↙
6:	10.2	↑
7:	10.2	↑
8:	10.6x	↗
9:	10.4	↓
10:	10.3	←
<b>Serie</b>		<b>99</b>
<b>Total</b>		<b>99</b>

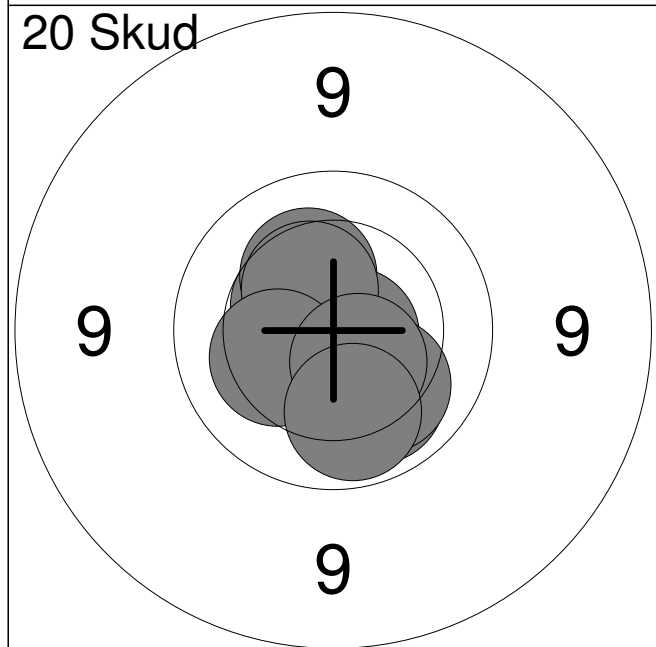

11:	10.5x	↗
12:	10.3	↗
13:	10.1	↙
14:	10.7x	↙
15:	10.7x	↘
16:	10.1	↙
17:	10.4	↗
18:	10.3	←
19:	10.5x	↙
20:	10.0	↓
<b>Serie</b>		<b>100</b>
<b>Total</b>		<b>199</b>

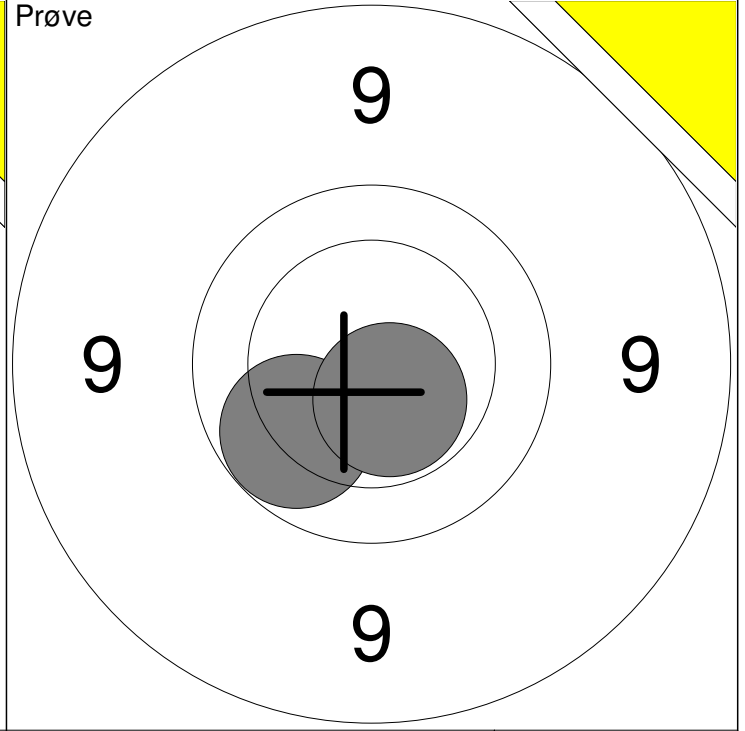
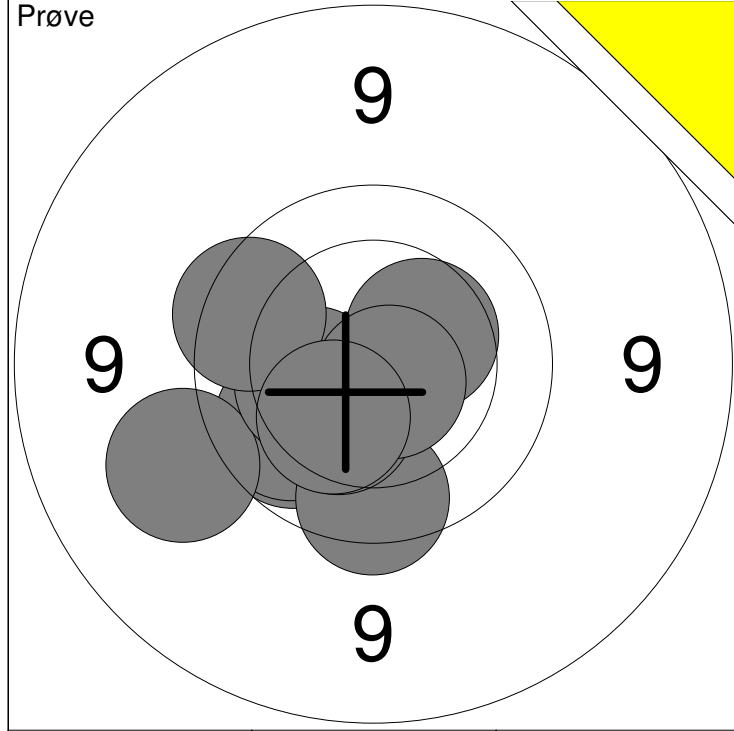

1: 9.9 ↙	6: 10.3 ↘	Serie	95
2: 10.4 ↗	7: 10.3 ←		
3: 9.9 ↙	8: 10.7x ↘	Total	0
4: 9.3 ←	9: 9.8 ←		
5: 9.8 ↓	10: 10.3 ↘		

11: 10.0 ↙	Serie	20
12: 10.6x ↘		
	Total	0

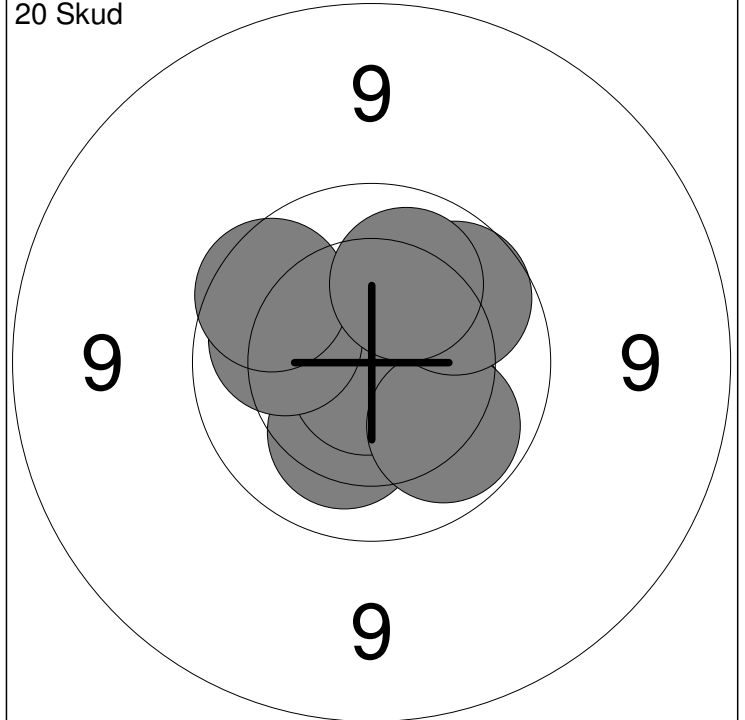
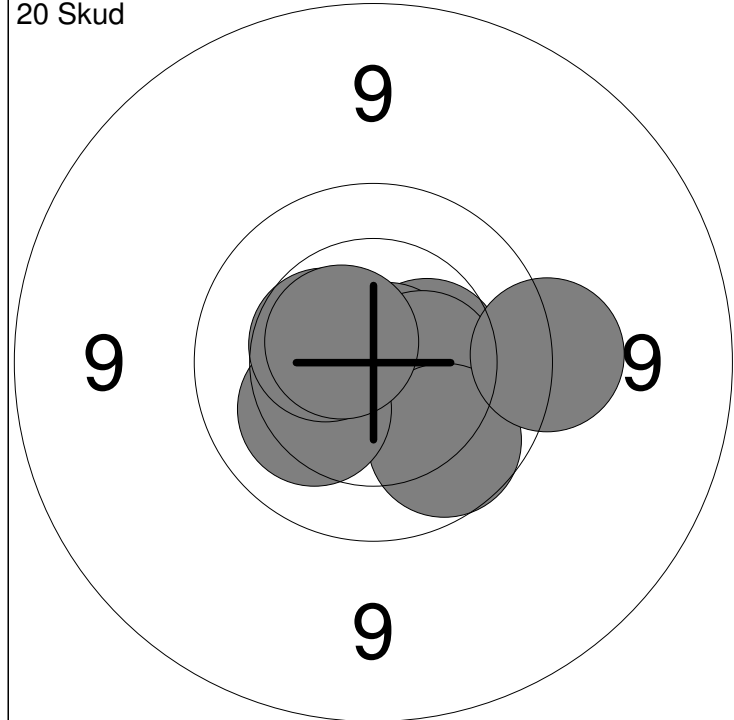

1: 10.8x ↗	6: 9.9 ↘	Serie	98
2: 10.6x ↘	7: 10.2 ←		
3: 10.4 →	8: 9.6 →	Total	98
4: 10.8x →	9: 10.5 ←		
5: 10.5 →	10: 10.6x ↙		

11: 10.2 ↘	16: 10.1 ←	Serie	98
12: 10.9x ↑	17: 10.0 ↘		
13: 10.6x ↘	18: 9.8 ↙	Total	196
14: 10.2 ↘	19: 9.9 ↗		
15: 10.8x ↘	20: 10.1 ↑		

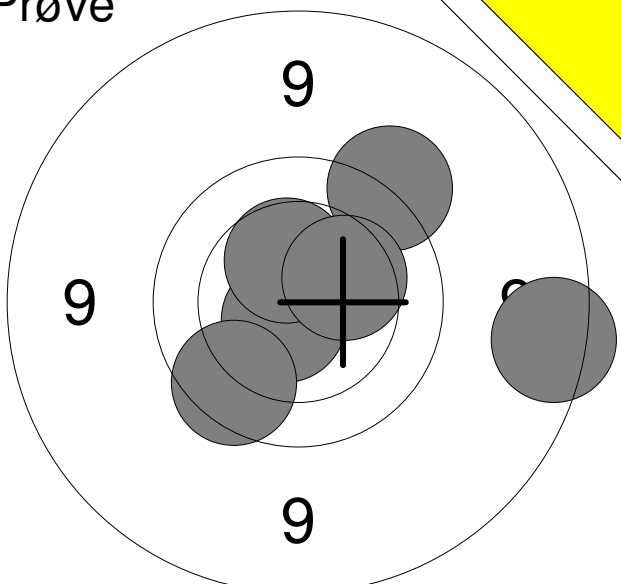
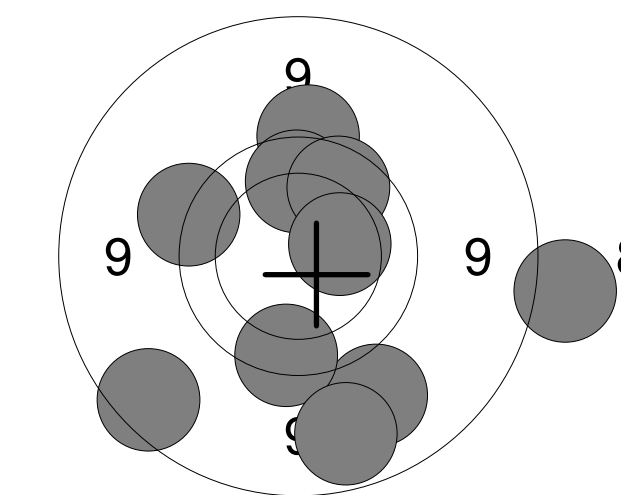
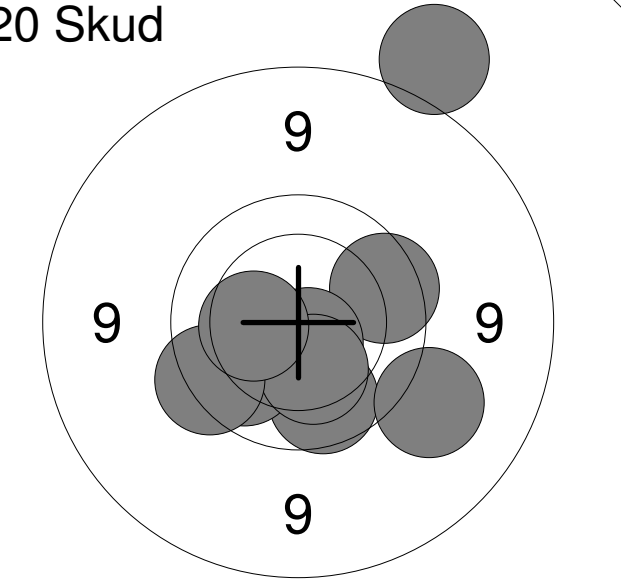
Hold <b>57</b>	Skive <b>3</b>	<b>Martin Jensen</b>		
Aalborg		Løgstør Sportsskytteklub		US2
		Nordjysk mesterskab 2018	Aalborg Skyttekreds	
<b>Prøve</b> 		1: 8.8 → 2: 10.7x ↓ 3: 9.5 ↗ 4: 10.4 ↑ 5: 10.3 → 6: 9.8 ↓		
		<b>Serie</b>	<b>56</b>	
		<b>Total</b>	<b>0</b>	
<b>20 Skud</b> 		1: 8.5 → 2: 9.5 ↑ 3: 9.9 ↑ 4: 9.9 ↗ 5: 9.2 ↓ 6: 9.5 ← 7: 9.7 ↓ 8: 8.8 ↙ 9: 10.3 → 10: 9.0 ↓		
		<b>Serie</b>	<b>89</b>	
		<b>Total</b>	<b>89</b>	
<b>20 Skud</b> 		11: 10.4 ↙ 12: 9.9 ↓ 13: 9.8 → 14: 10.0 ↙ 15: 10.6x ↓ 16: 10.3 ↓ 17: 9.7 ↙ 18: 10.3 ← 19: 8.5 ↗ 20: 9.3 ↘		
		<b>Serie</b>	<b>94</b>	
		<b>Total</b>	<b>183</b>	

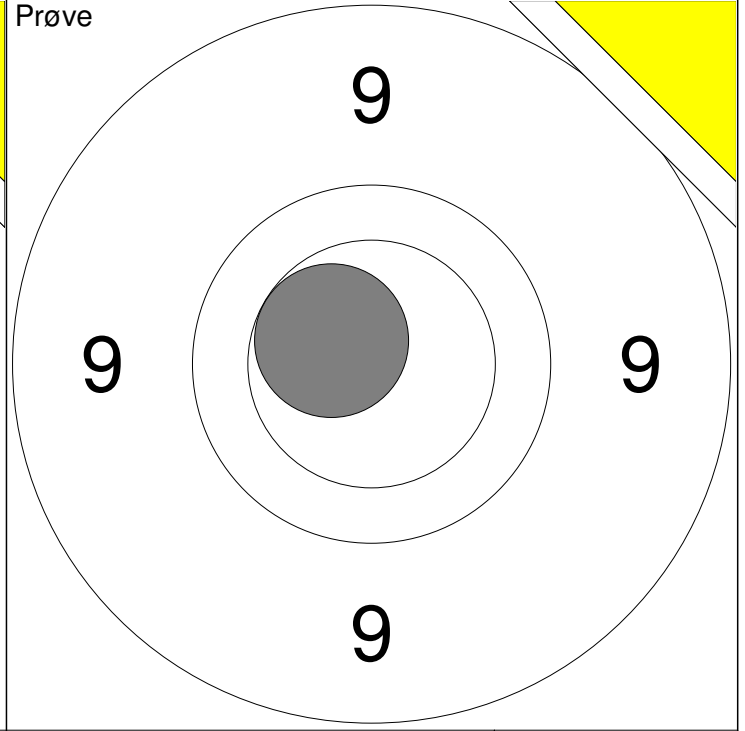
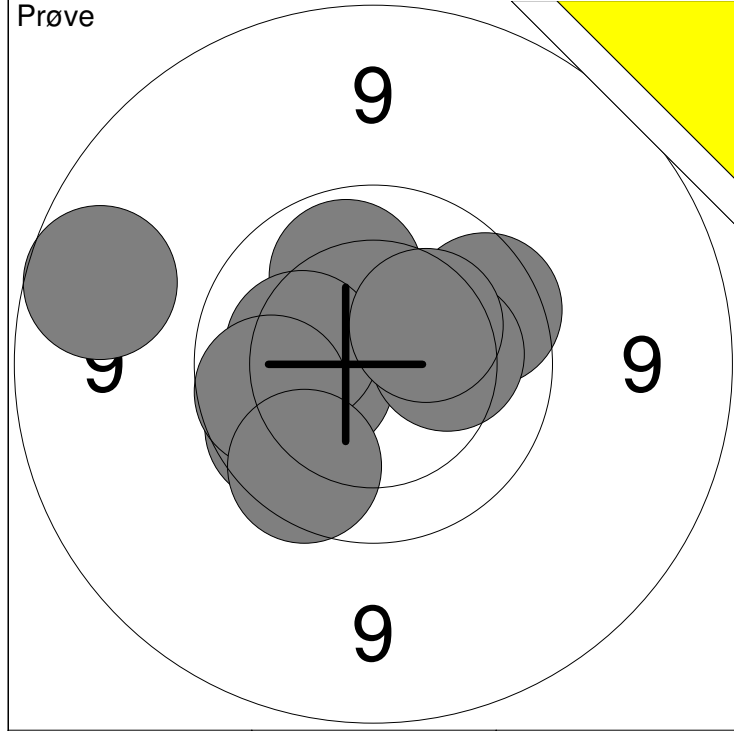

1: 10.1 ↗	6: 10.2 ←	Serie	94
2: 9.9 ↙	7: 9.9 ←		
3: 9.8 ↘	8: 9.8 ↘	Total	0
4: 8.9 ←	9: 10.2 →		
5: 10.4 ←	10: 10.3 ↗		

11: 10.5x ↙	Serie	10
	Total	0

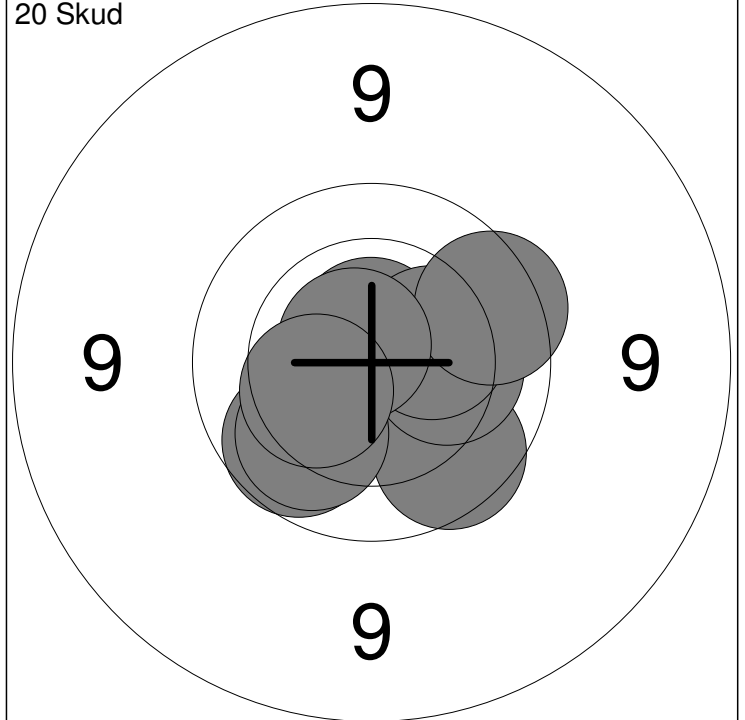
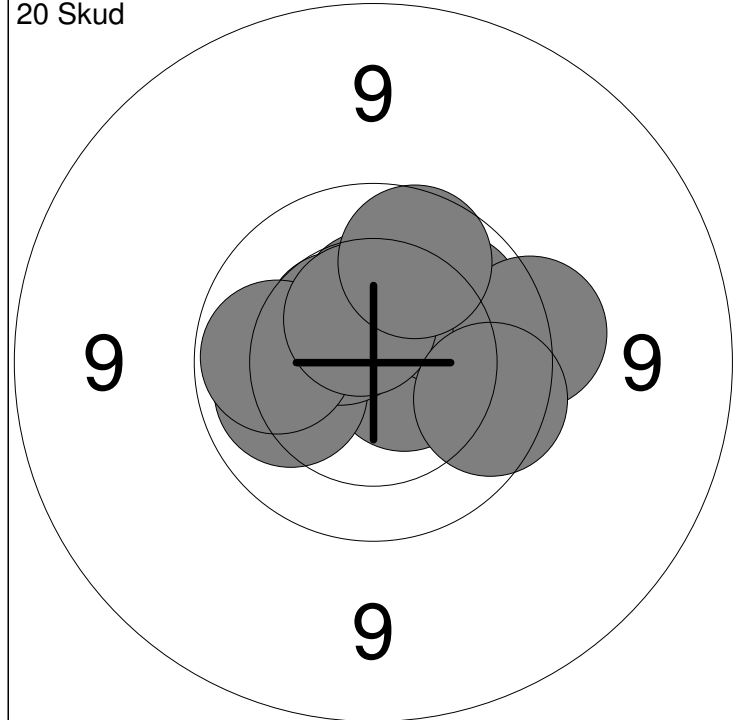

1: 10.4 ↗	6: 9.6 →	Serie	97
2: 10.6x →	7: 10.0 ←		
3: 10.1 ←	8: 10.5x ↗	Total	97
4: 10.5 ↙	9: 9.9 ↗		
5: 10.0 ↗	10: 9.8 →		

11: 10.7x ↗	16: 10.2 →	Serie	97
12: 10.8x →	17: 10.3 →		
13: 9.9 ↘	18: 9.8 ↘	Total	194
14: 9.9 ↙	19: 10.7x ↙		
15: 10.0 ↙	20: 10.3 ←		

Hold <b>57</b>	Skive <b>11</b>	<b>Arne Holm</b>		
Aalborg		Aalborg Skyttekreds		SE2
		Nordjysk mesterskab 2018	Aalborg Skyttekreds	
Prøve		1:	9.2	➔
		2:	10.4	➡
		3:	9.9	↖
		4:	10.8x	➔
		5:	9.8	↗
		6:	10.1	↗
		7:	10.7x	➔
		8:	10.5	➔
		Serie	77	
		Total	0	
20 Skud		1:	9.5	➡
		2:	10.2	↘
		3:	10.8x	↗
		4:	10.6x	↗
		5:	10.5	↗
		6:	10.4	➡
		7:	10.8x	➡
		8:	10.6x	↗
		9:	10.3	↖
		10:	10.2	↘
		Serie	99	
		Total	99	
20 Skud		11:	9.8	↖
		12:	10.2	↗
		13:	10.1	↘
		14:	9.9	↗
		15:	10.4	↗
		16:	10.0	↘
		17:	10.7x	➡
		18:	10.4	↗
		19:	9.9	➔
		20:	9.9	↗
		Serie	96	
		Total	195	

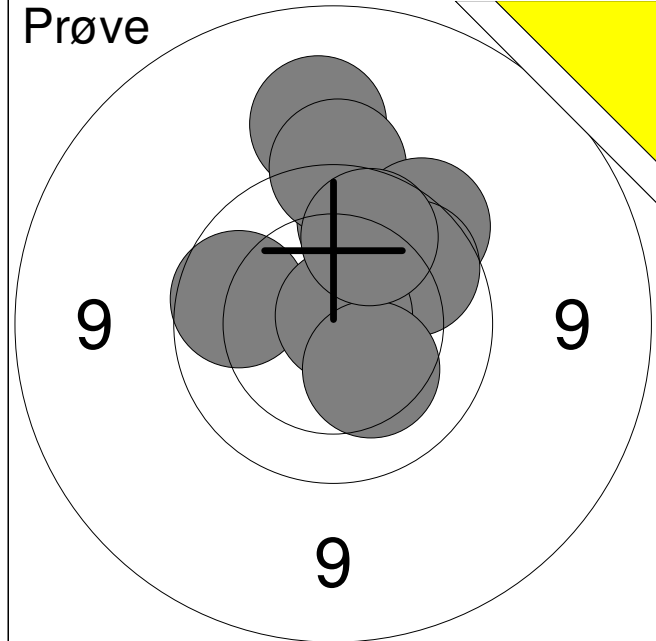

1:	9.9	←
2:	9.3	↑
3:	9.8	↑
4:	9.5	↑
5:	9.7	↗
6:	9.9	↗
7:	10.8x	↗
8:	10.3	↘
9:	9.9	↑
<b>Serie</b>		<b>83</b>
<b>Total</b>		<b>0</b>

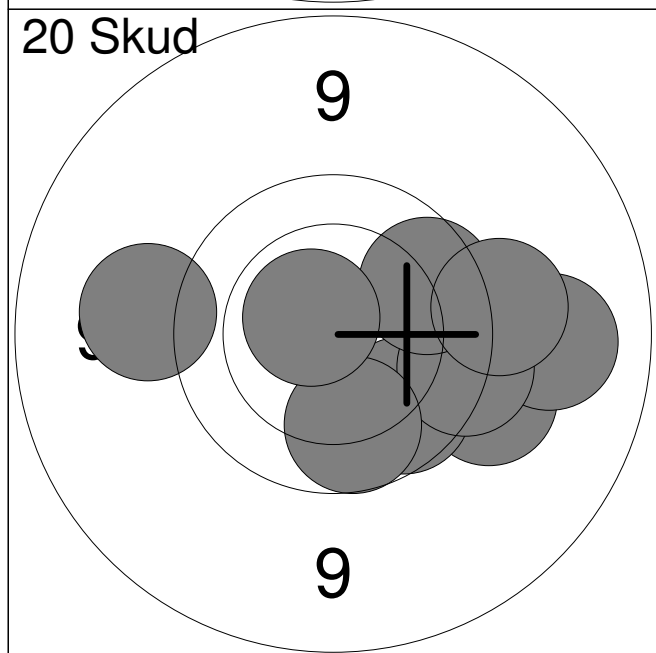

1:	9.5	↘
2:	9.8	→
3:	9.2	→
4:	9.3	←
5:	9.9	↘
6:	9.7	↘
7:	9.9	↘
8:	9.9	↗
9:	9.5	→
10:	10.6x	↗
<b>Serie</b>		<b>91</b>
<b>Total</b>		<b>91</b>

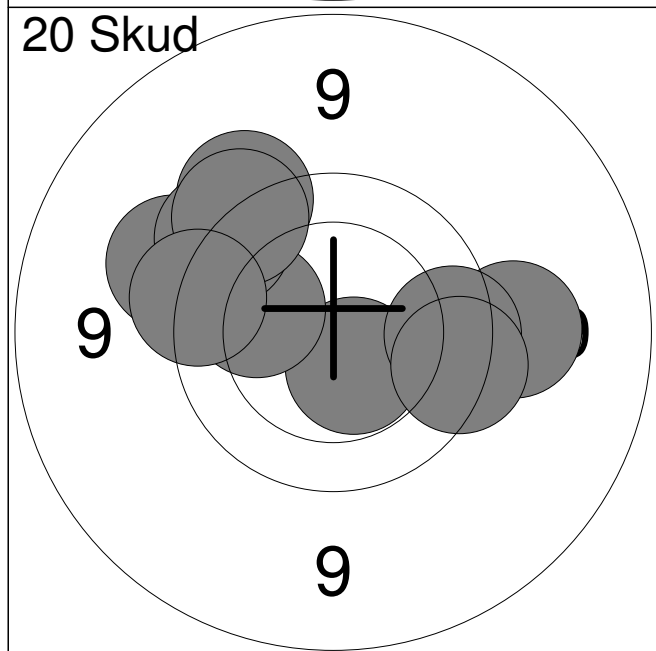

11:	10.5x	↘
12:	10.1	←
13:	9.5	↗
14:	9.4	↖
15:	9.6	↗
16:	9.6	↗
17:	9.6	←
18:	9.4	→
19:	9.8	→
20:	9.7	↘
<b>Serie</b>		<b>92</b>
<b>Total</b>		<b>183</b>

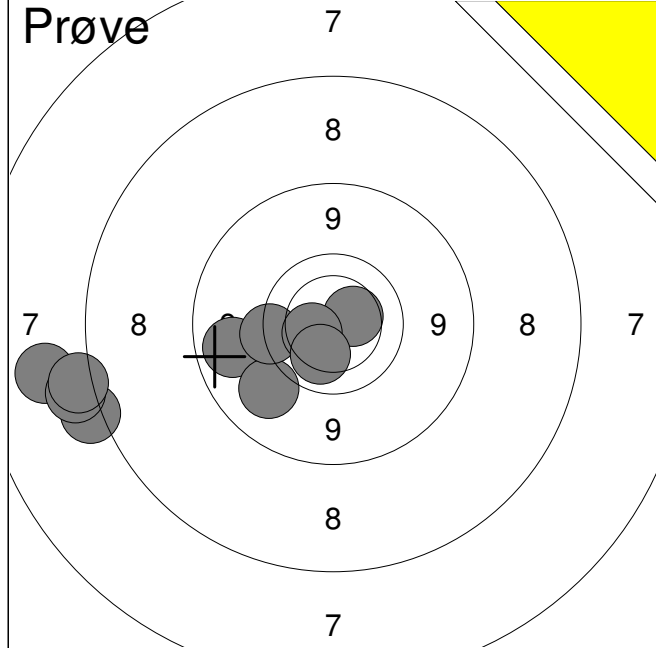

1:	7.6	←
2:	7.3	←
3:	7.5	←
4:	7.5	←
5:	9.1	←
6:	9.2	↙
7:	9.6	←
8:	10.4	→
9:	10.4	←
10:	10.1	↓

Serie	<b>85</b>
-------	-----------

Total	<b>0</b>
-------	----------

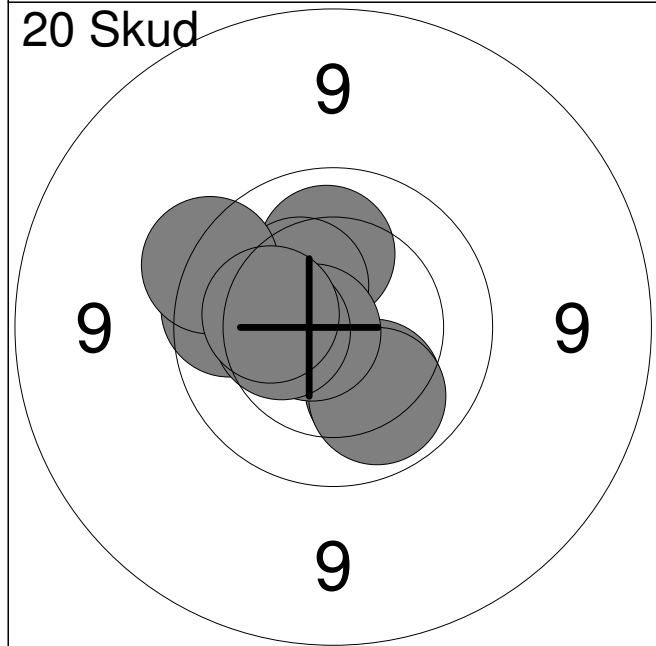

1:	10.5x	↗
2:	10.1	↑
3:	10.1	↘
4:	9.9	←
5:	10.0	↘
6:	10.4	↗
7:	9.7	↗
8:	10.7x	←
9:	10.4	←
10:	10.2	←

Serie	<b>98</b>
-------	-----------

Total	<b>98</b>
-------	-----------

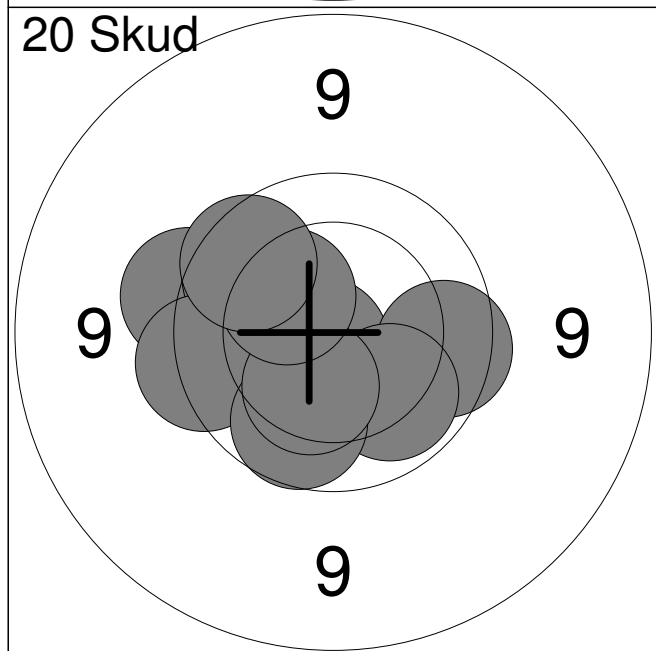

11:	9.6	←
12:	9.9	↗
13:	9.7	←
14:	10.7x	↘
15:	9.8	→
16:	10.0	↘
17:	9.9	↘
18:	10.3	↘
19:	10.3	↗
20:	9.8	↗

Serie	<b>94</b>
-------	-----------

Total	<b>192</b>
-------	------------

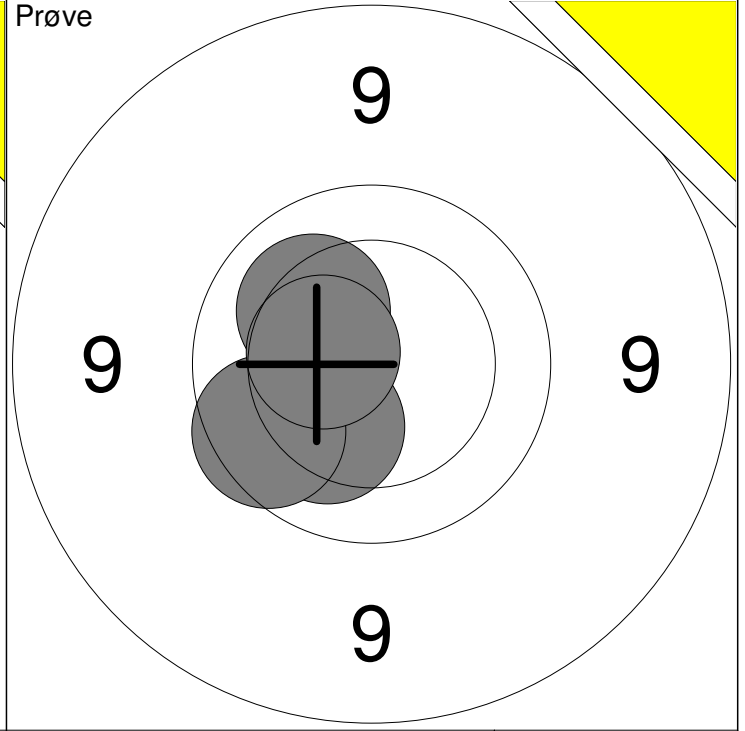
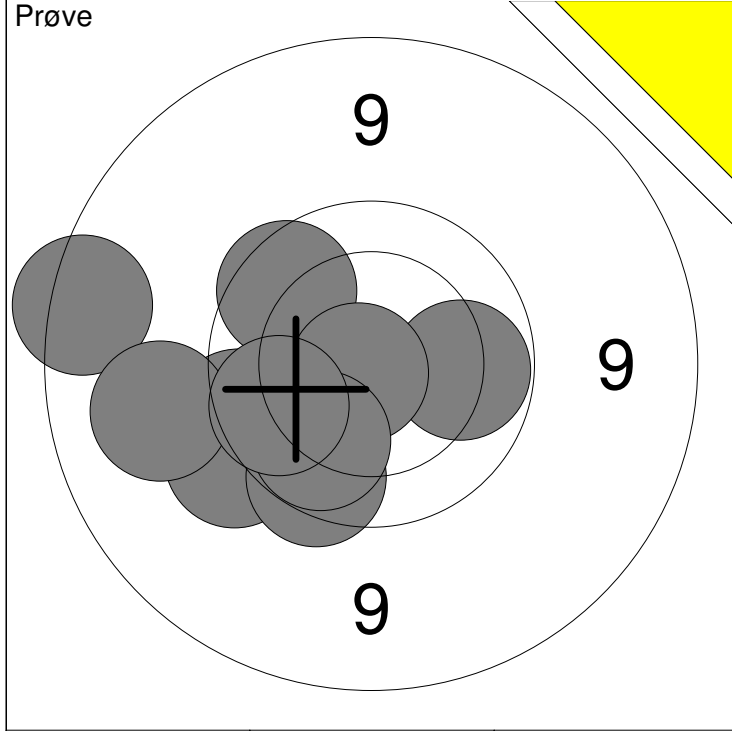

1: 8.8 ↙	6: 10.0 →	Serie	92
2: 9.6 ↙	7: 9.2 ↙		
3: 9.8 ↗	8: 10.8x ↙	Total	0
4: 9.5 ↙	9: 10.0 ↘		
5: 9.8 ↘	10: 9.9 ↙		

11: 10.2 ↘	Serie	39
12: 9.8 ↙		
13: 10.2 ↗	Total	0
14: 10.5 ↙		

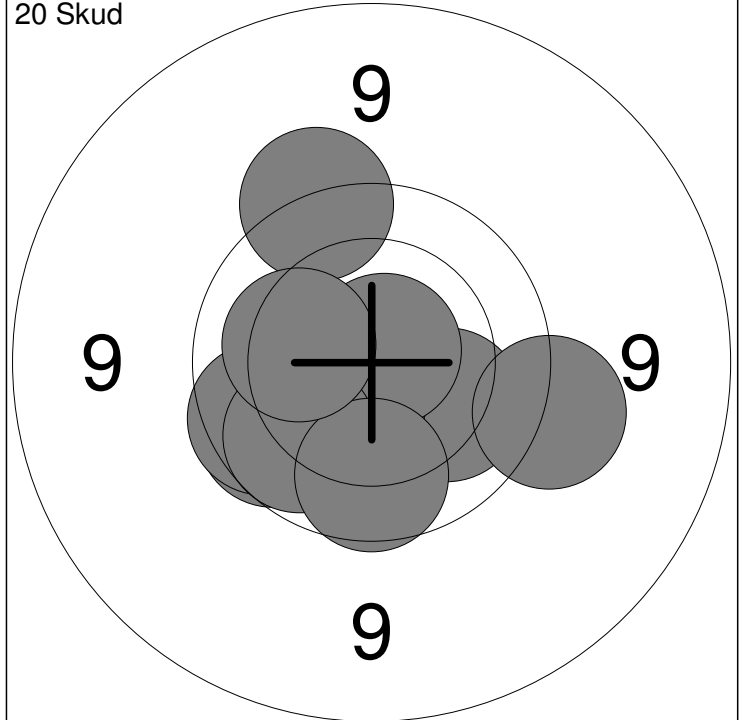
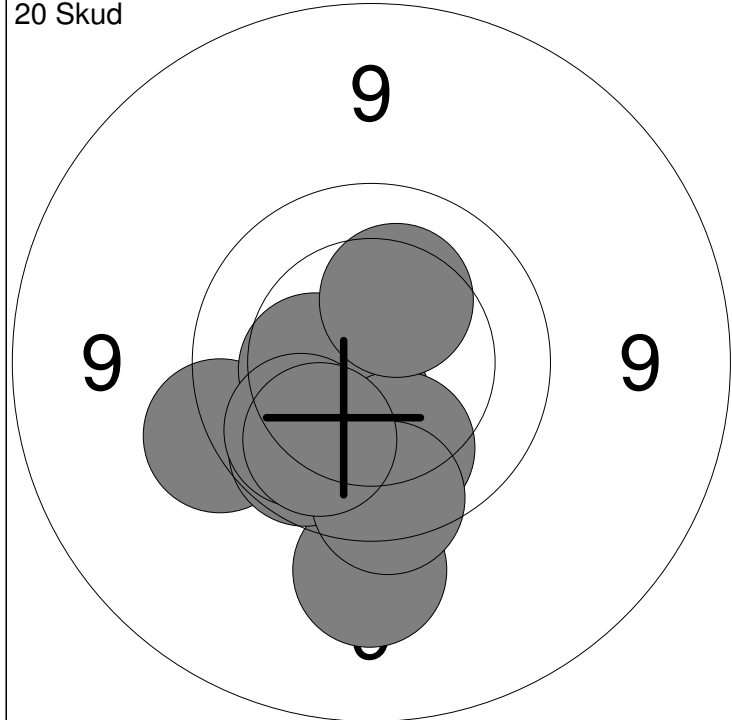

1: 9.6 ↙	6: 10.3 ↗	Serie	96
2: 10.5x ↘	7: 9.9 ↙		
3: 10.4 ↙	8: 9.8 ↘	Total	96
4: 9.4 ↘	9: 10.0 ↙		
5: 10.1 ↘	10: 10.0 ↘		

11: 10.1 →	16: 10.8x ↗	Serie	94
12: 9.6 ↗	17: 9.5 →		
13: 9.9 ↙	18: 9.9 ↘	Total	190
14: 10.6x ↘	19: 9.9 ↘		
15: 9.8 ↙	20: 10.2 ↙		



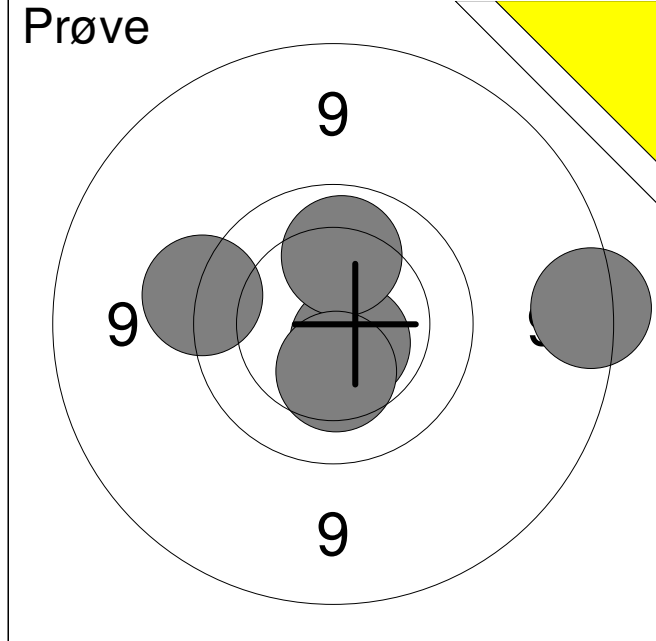

1:	8.8	→
2:	10.6x	↘
3:	10.1	↑
4:	10.3	↓
5:	9.6	←
<b>Serie</b>		<b>47</b>
<b>Total</b>		<b>0</b>

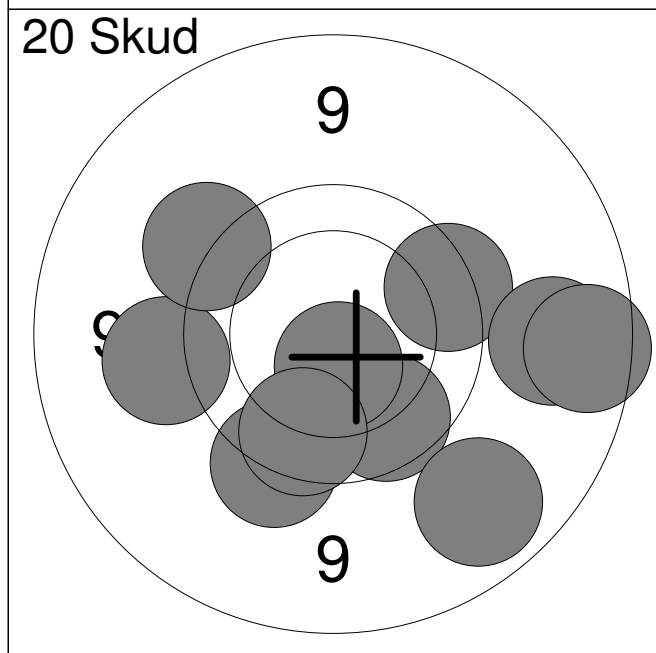

1:	9.4	←
2:	9.9	↘
3:	9.7	→
4:	9.1	→
5:	9.5	↗
6:	9.6	↓
7:	10.6x	↓
8:	8.9	→
9:	9.0	↘
10:	9.8	↓
<b>Serie</b>		<b>90</b>
<b>Total</b>		<b>90</b>

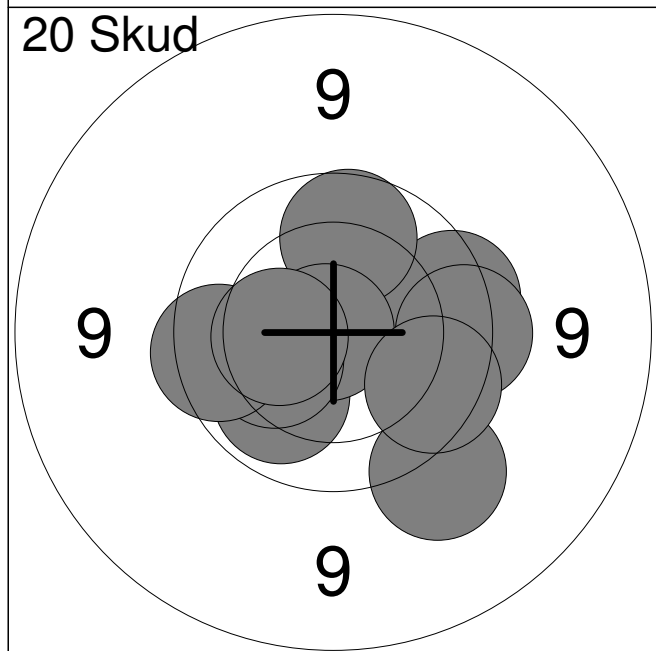

11:	9.4	↘
12:	9.7	→
13:	9.9	↑
14:	10.1	↘
15:	9.7	→
16:	10.9x	←
17:	10.2	←
18:	9.8	←
19:	10.4	←
20:	9.8	↘
<b>Serie</b>		<b>94</b>
<b>Total</b>		<b>184</b>

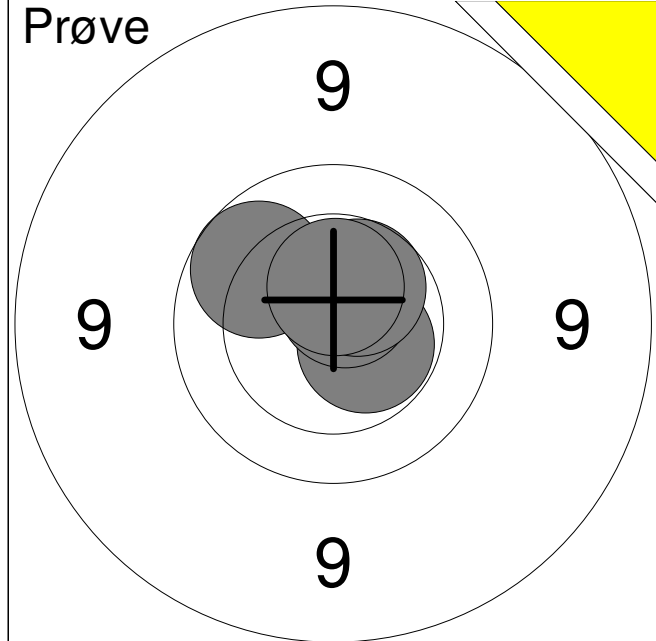

1:	9.9	↗
2:	10.5x	↘
3:	10.6x	↗
4:	10.5	↗
5:	10.5x	↑
<b>Serie</b>		<b>49</b>
<b>Total</b>		<b>0</b>

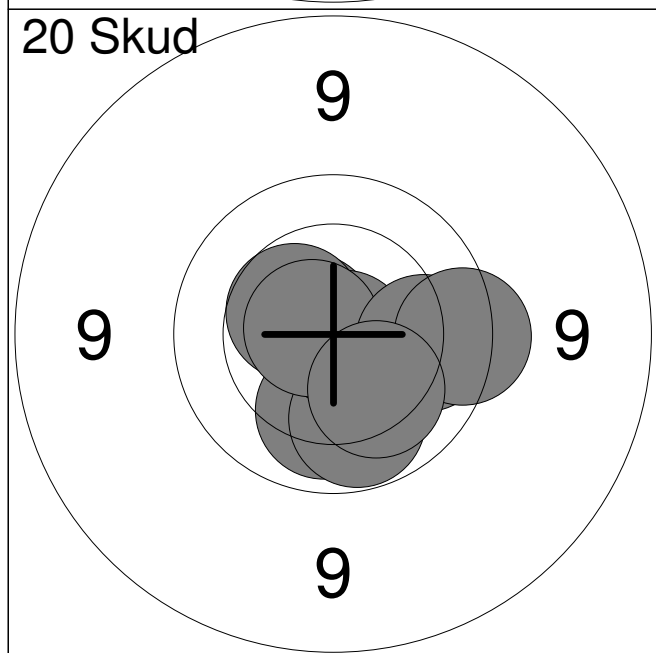

1:	10.6x	↗
2:	10.5	↗
3:	10.5x	↘
4:	10.1	↘
5:	10.0	↘
6:	10.8x	↘
7:	10.7x	↗
8:	9.9	→
9:	9.7	→
10:	10.2	↘
<b>Serie</b>		<b>98</b>
<b>Total</b>		<b>98</b>

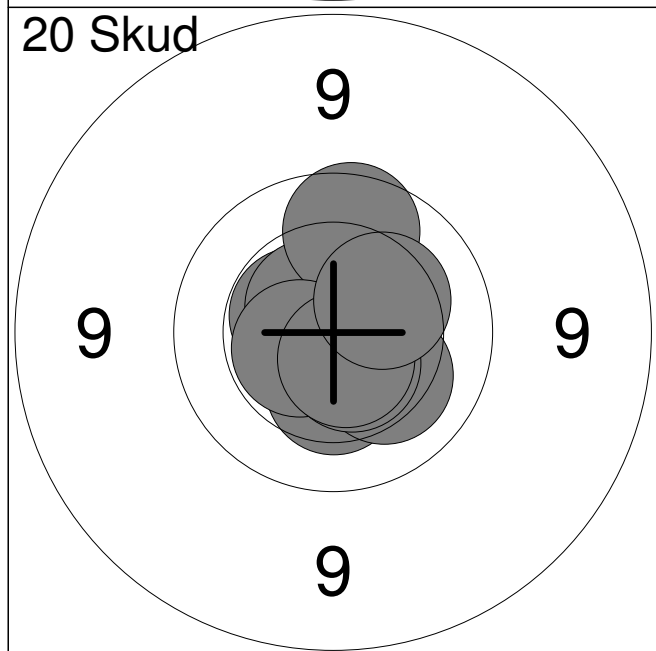

11:	10.4	↘
12:	10.5x	↗
13:	10.6x	↗
14:	9.9	↑
15:	10.4	↘
16:	10.5x	↖
17:	10.2	↘
18:	10.6x	↘
19:	10.6x	↘
20:	10.3	↗
<b>Serie</b>		<b>99</b>
<b>Total</b>		<b>197</b>

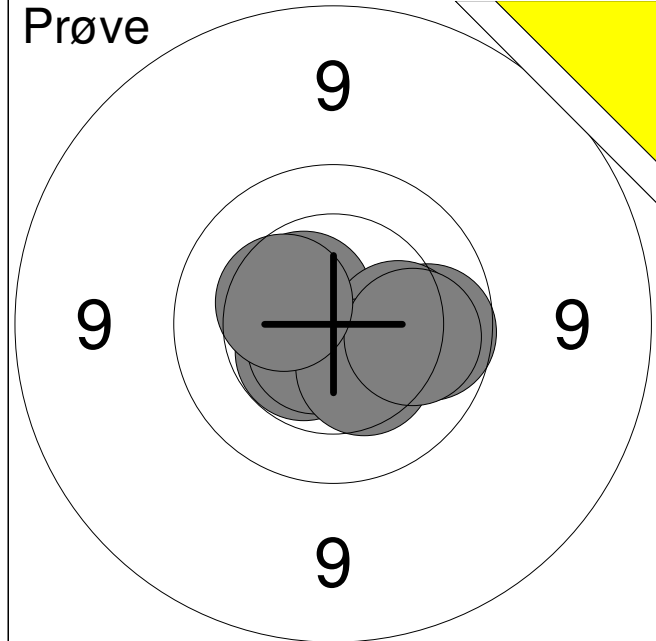

1:	10.5x	↙
2:	10.5x	↗
3:	9.9	→
4:	10.6x	↙
5:	10.2	→
6:	10.4	↘
7:	10.1	→
8:	10.4	↖
<b>Serie</b>		<b>79</b>
<b>Total</b>		<b>0</b>

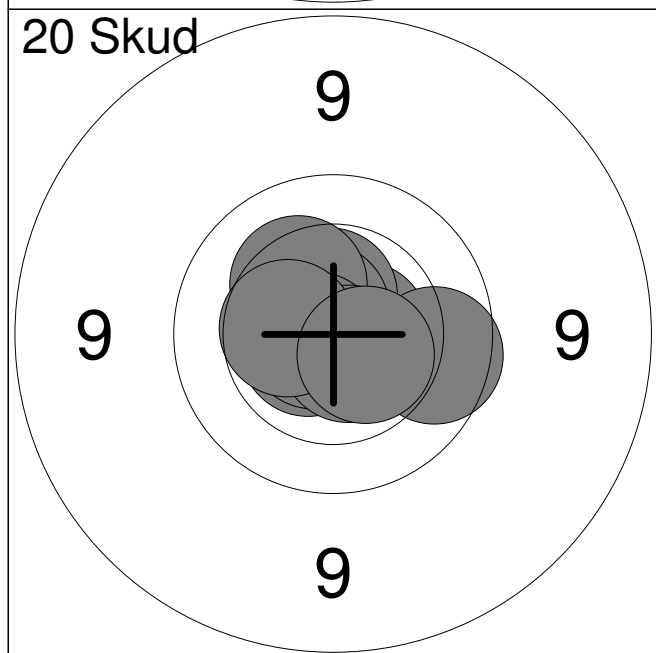

1:	10.6x	→
2:	9.9	→
3:	10.5x	↑
4:	10.7x	↗
5:	10.3	↗
6:	10.6x	↙
7:	10.7x	↙
8:	10.7x	↘
9:	10.4	←
10:	10.5x	↘
<b>Serie</b>		<b>99</b>
<b>Total</b>		<b>99</b>

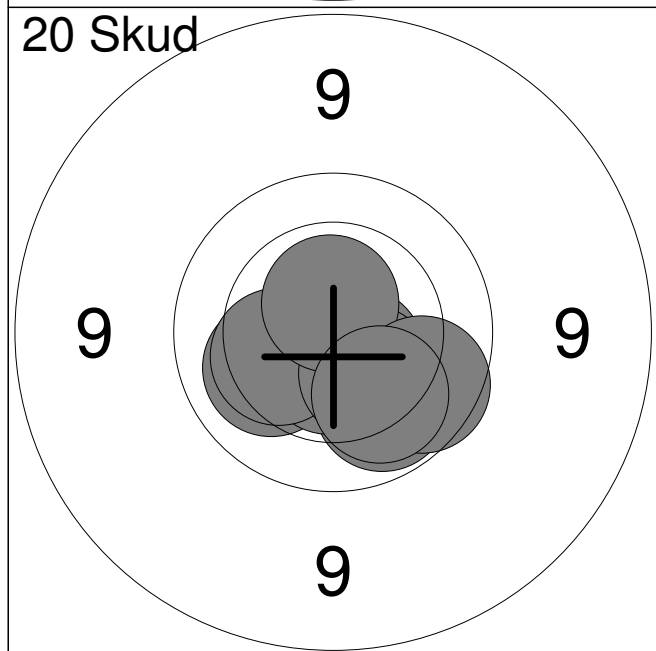

11:	10.2	↙
12:	10.6x	↓
13:	10.6x	↘
14:	10.0	↘
15:	10.6x	↓
16:	10.3	↙
17:	10.4	↘
18:	10.6x	↑
19:	9.9	↘
20:	10.1	↘
<b>Serie</b>		<b>99</b>
<b>Total</b>		<b>198</b>

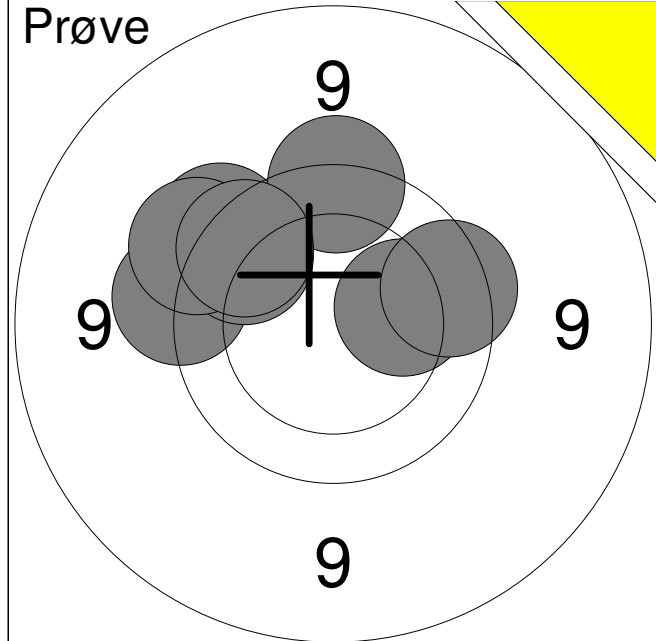

1:	9.5	←
2:	10.2	→
3:	9.8	↗
4:	9.6	↗
5:	9.5	↗
6:	9.6	↑
7:	9.8	↗
8:	9.8	→
<b>Serie</b>		<b>73</b>
<b>Total</b>		<b>0</b>

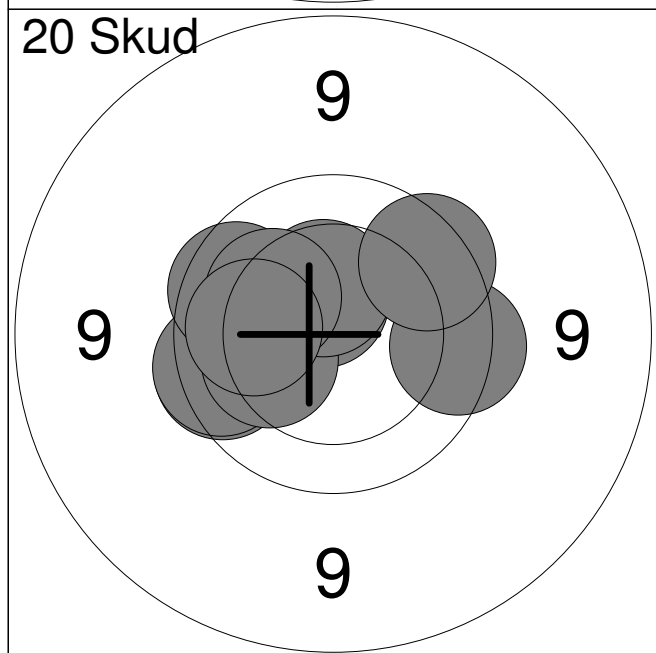

1:	10.5x	↑
2:	9.8	←
3:	9.8	←
4:	10.2	←
5:	9.9	↖
6:	9.7	→
7:	10.4	↑
8:	10.2	↖
9:	10.1	←
10:	9.8	↗
<b>Serie</b>		<b>95</b>
<b>Total</b>		<b>95</b>

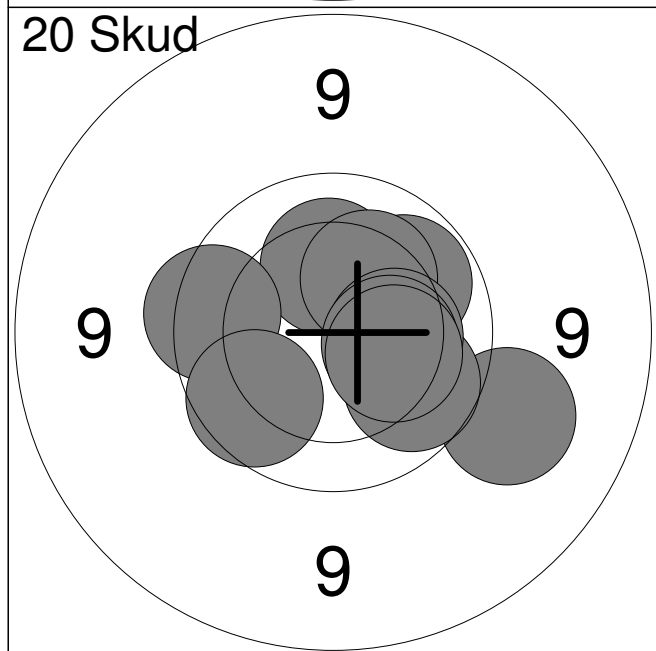

11:	9.3	↘
12:	9.9	↘
13:	10.2	↑
14:	10.0	↗
15:	10.2	↗
16:	9.8	←
17:	10.3	→
18:	9.9	↙
19:	10.3	→
20:	10.2	↘
<b>Serie</b>		<b>96</b>
<b>Total</b>		<b>191</b>

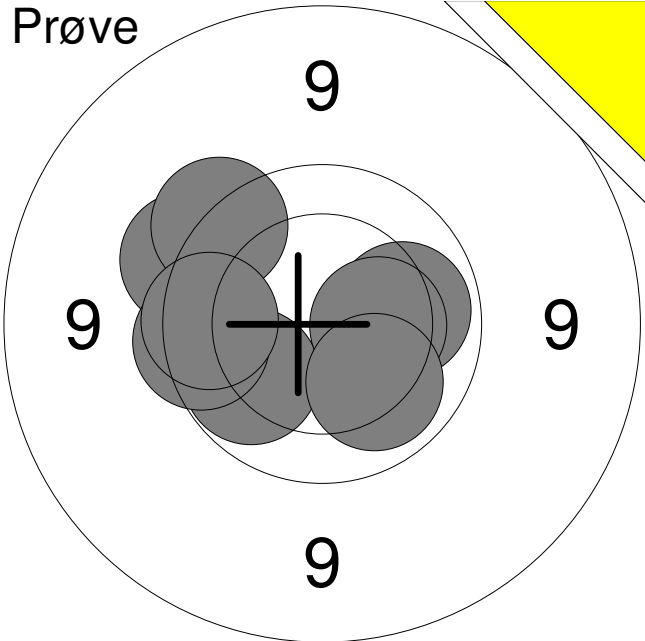
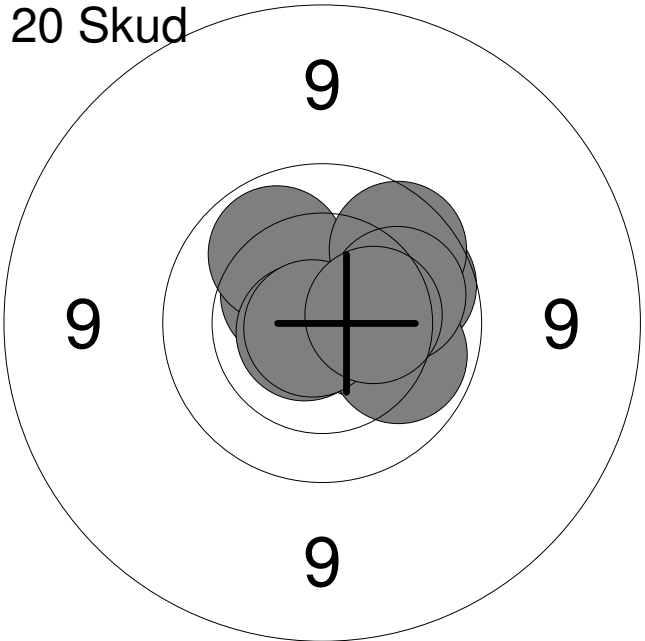
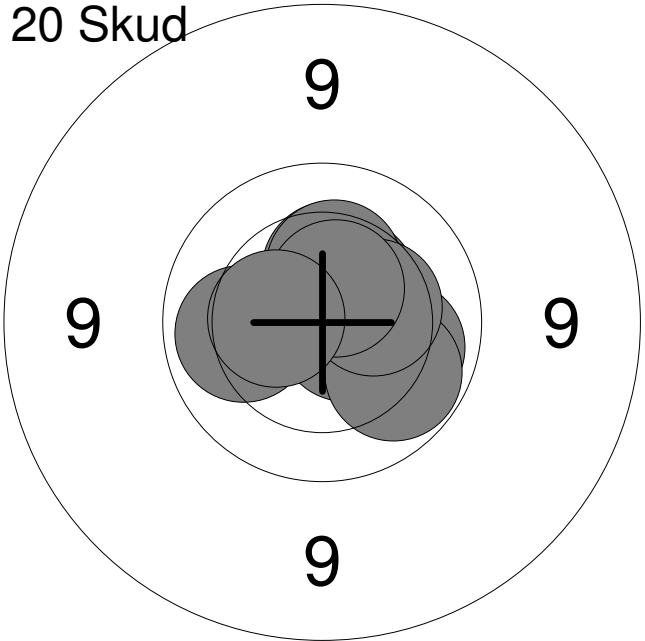
Hold <b>59</b>	Skive <b>6</b>	<b>Jens Nielsen</b>		
Aalborg		Aalborg Skyttekreds		MVÅ2
		Nordjysk mesterskab 2018	Aalborg Skyttekreds	
Prøve		1:	10.0	↙
		2:	9.6	↖
		3:	9.6	↗
		4:	10.0	→
		5:	9.8	←
		6:	10.3	→
		7:	9.8	←
		8:	10.1	↘
		Serie		76
		Total		0
20 Skud		1:	10.5	↗
		2:	9.9	→
		3:	10.0	↗
		4:	9.9	↗
		5:	10.7x	←
		6:	10.5	→
		7:	10.0	↘
		8:	10.1	→
		9:	10.8x	←
		10:	10.4	→
		Serie		98
		Total		98
20 Skud		11:	10.4	↑
		12:	10.1	←
		13:	10.1	↘
		14:	10.7x	↘
		15:	10.0	↘
		16:	10.5	↗
		17:	10.3	↑
		18:	10.4	→
		19:	10.5x	↑
		20:	10.4	←
		Serie		100
		Total		198

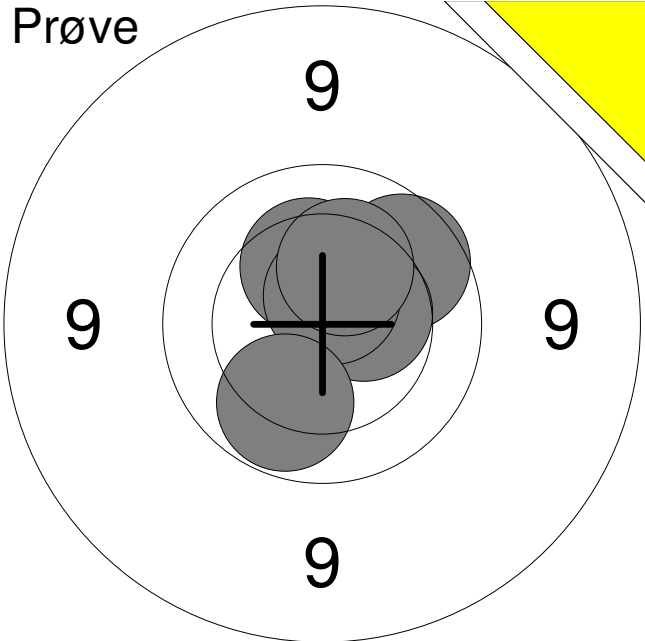
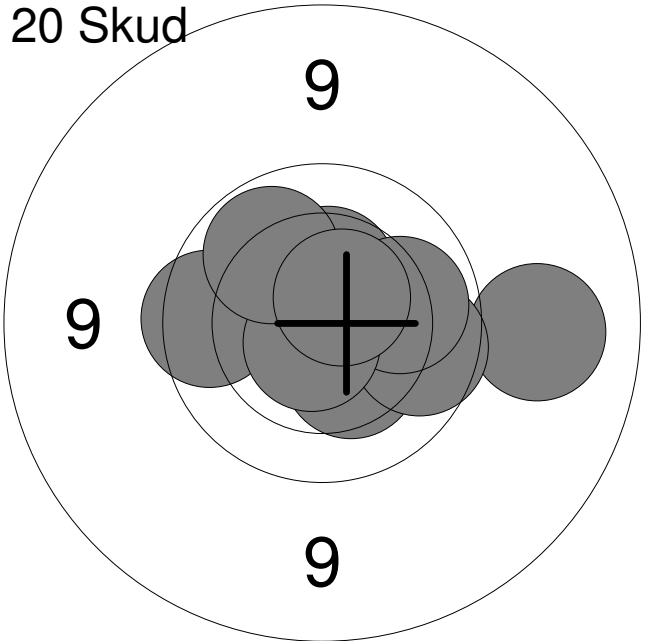
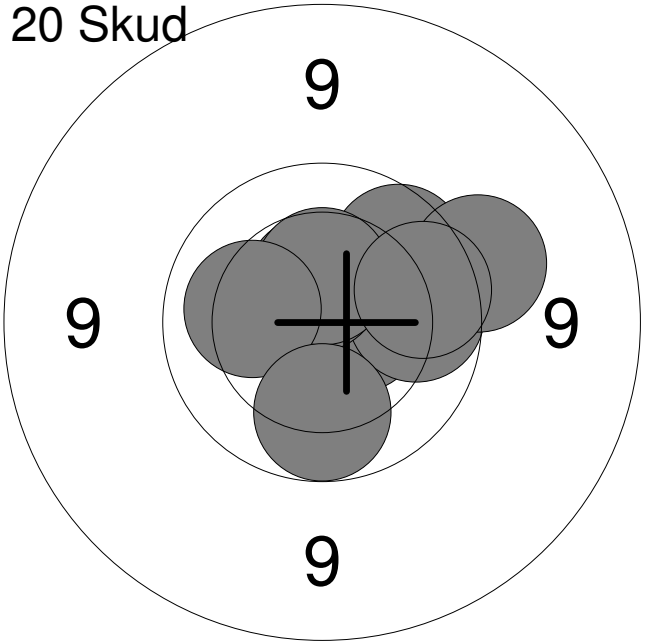
Hold <b>59</b>	Skive <b>9</b>	<b>Emil Lindholt Nielsen</b>		
Aalborg		Aalborg Skyttekreds		MUS1
		Nordjysk mesterskab 2018	Aalborg Skyttekreds	
<b>Prøve</b> 		1: 10.3 ↑ 2: 9.9 ↗ 3: 10.5 → 4: 10.6x ↑ 5: 10.0 ↓ 6: 10.3 ↗	<b>Serie</b> 59 <b>Total</b> 0	
<b>20 Skud</b> 		1: 9.8 ← 2: 10.4 ↑ 3: 9.2 → 4: 10.7x ↗ 5: 10.3 ↓ 6: 9.9 → 7: 10.1 → 8: 10.7x ↓ 9: 10.0 ↗ 10: 10.6x ↗	<b>Serie</b> 97 <b>Total</b> 97	
<b>20 Skud</b> 		11: 10.6x → 12: 10.3 ↗ 13: 9.9 → 14: 10.5x ↑ 15: 9.9 ↗ 16: 9.5 → 17: 10.4 ↑ 18: 10.2 ← 19: 10.0 ↓ 20: 9.9 →	<b>Serie</b> 96 <b>Total</b> 193	

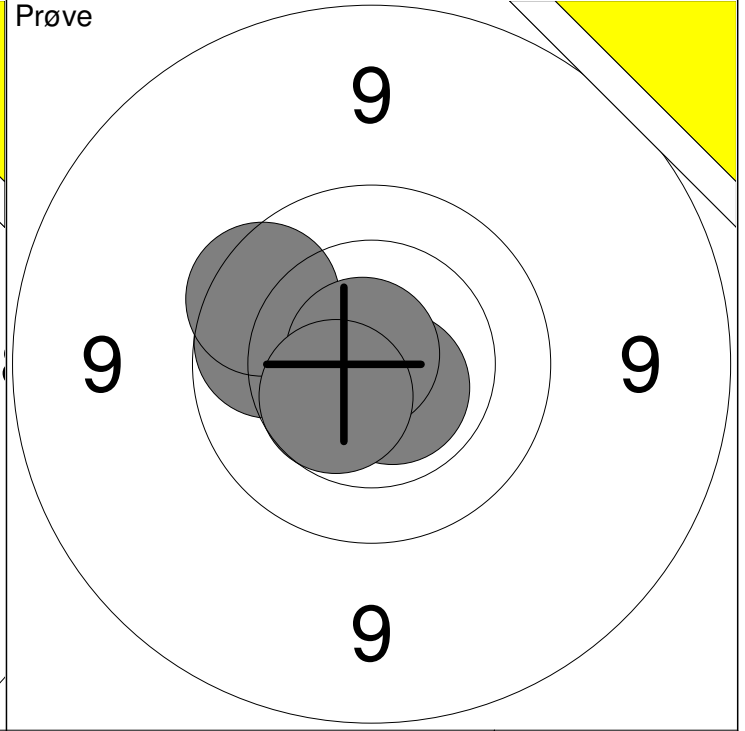
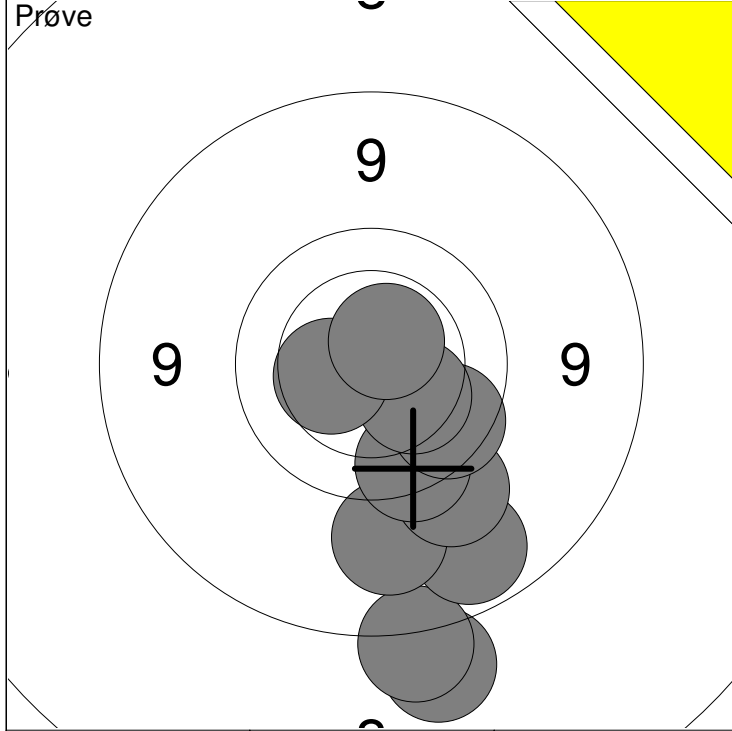

1: 8.5 ↓	6: 9.7 ↓	Serie	91
2: 8.6 ↓	7: 9.8 ↓		
3: 9.0 ↓	8: 10.3 ↓		
4: 9.2 ↓	9: 10.4 ←		
5: 9.4 ↓	10: 10.6x ↗		
Total			0

11: 10.6x ↓	Serie	48
12: 9.9 ←		
13: 9.8 ↗		
14: 10.8x ↗		
15: 10.5 ↓		
Total		0

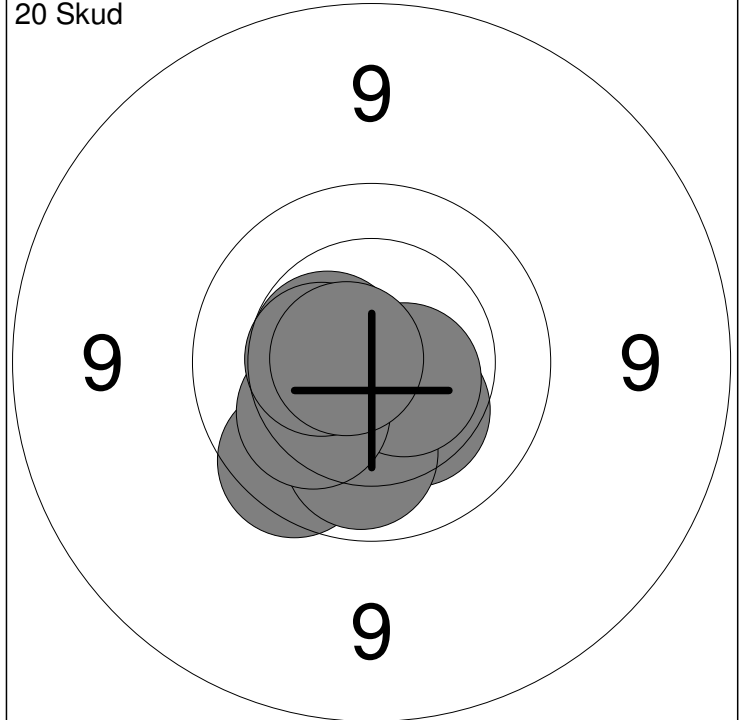
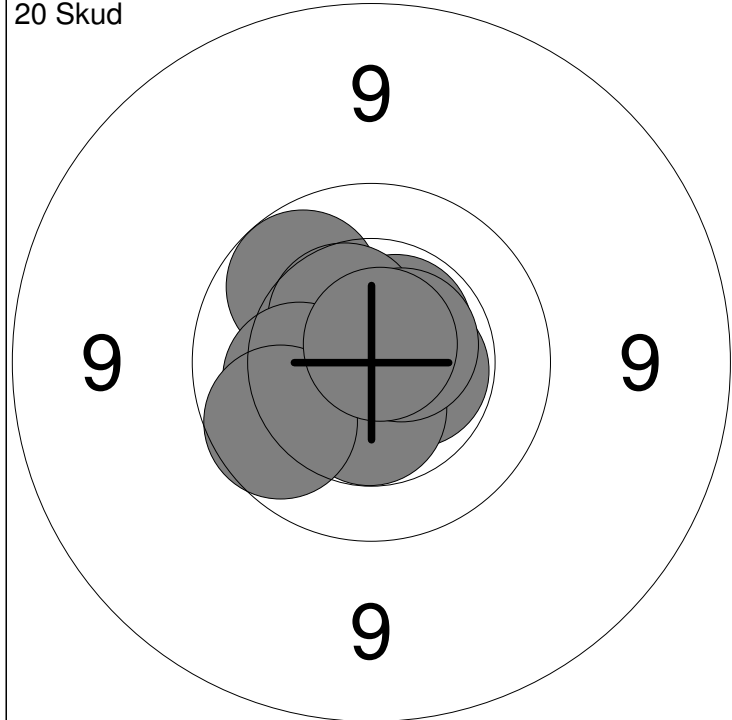

1: 10.0 ↗	6: 10.2 ←	Serie	99
2: 10.6x ↗	7: 10.5x ↓		
3: 10.5 ↗	8: 10.6x ↗		
4: 10.5x →	9: 9.9 ←		
5: 10.5x ↓	10: 10.8x ↗		
Total			99

11: 10.6x ←	16: 10.6x →	Serie	99
12: 10.8x ↓	17: 10.2 ↓		
13: 9.8 ↓	18: 10.5x ←		
14: 10.3 ↓	19: 10.5 ←		
15: 10.1 ↓	20: 10.7x ←		
Total			198